

DIMENSIONS

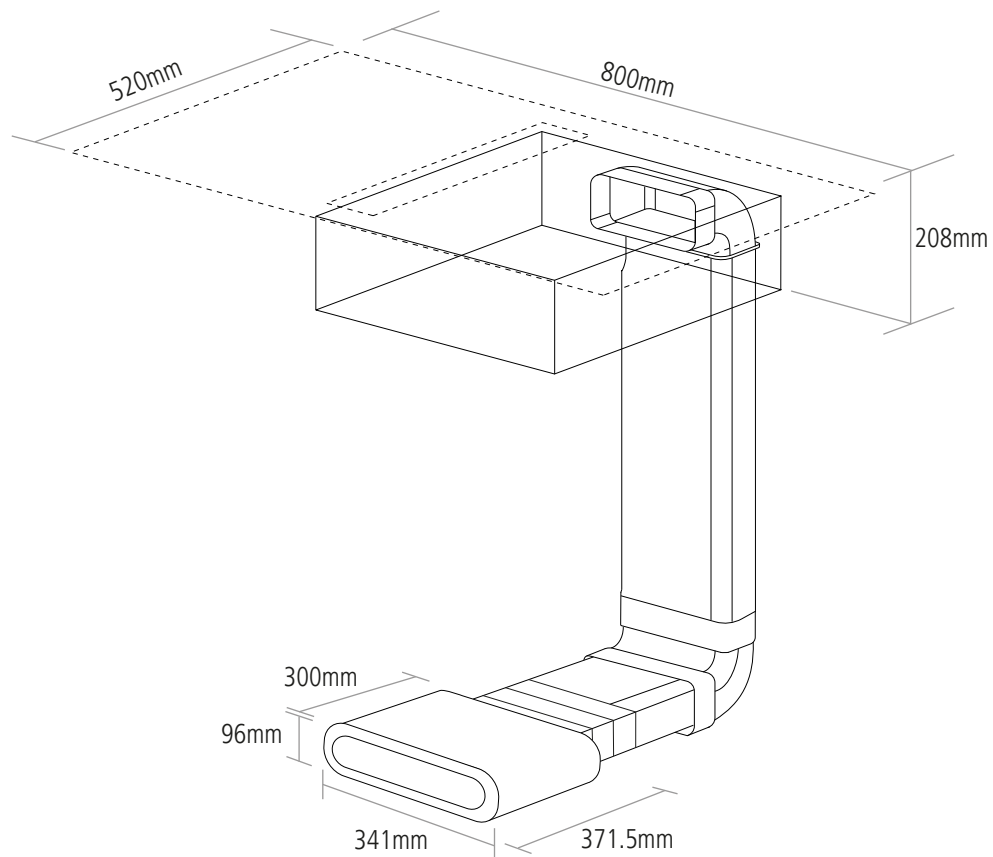

*Inset cut-out 750 x 500mm. Refer to manual for further information.