

SASO22/26

Installation Guide

Your SASO sink is designed to be installed into your worktop surface. Four side pieces and a top surface section are cut out of your selected worktop material and then fitted around the sink.

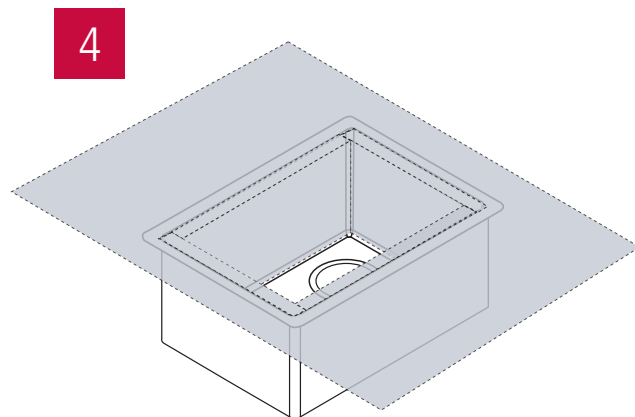
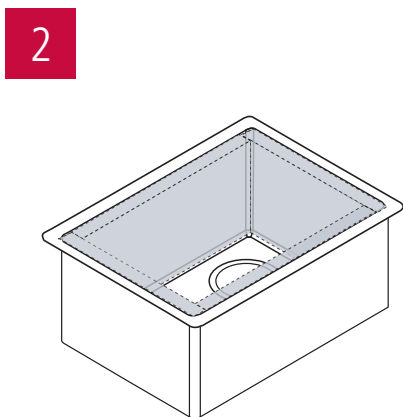
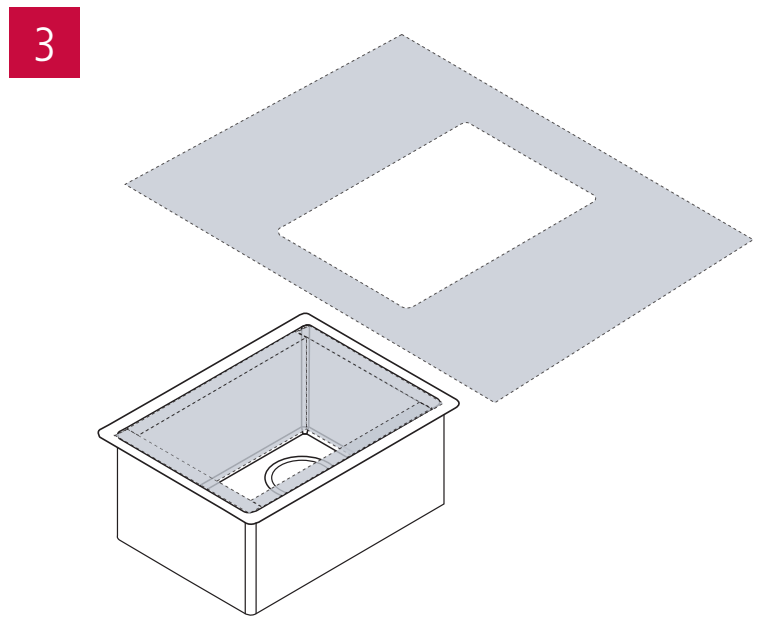
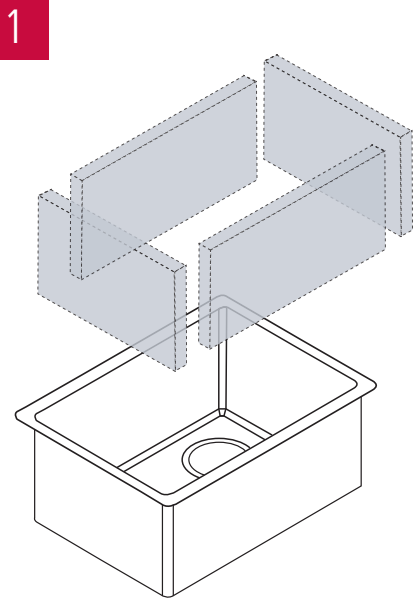

NOTE:

As there are several ways the sink can be installed into your worktop, please consult your chosen worktop fabricator to discuss your requirements further.

Sink dimensions to be used for creating the template pieces for installation:

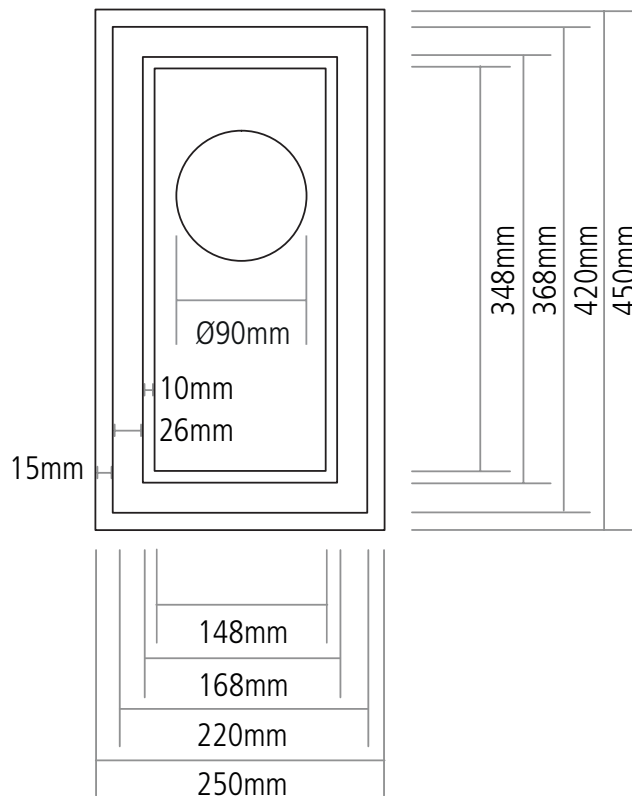
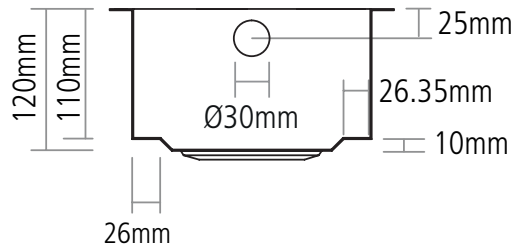

Scan the following QR Code to access further information and an example installation video and guide:

