



Ceiling Hood
Instruction Manual

**CE902SS/
CE902WH**



Contact Caple on 0117 938 7420 for spare parts or www.caple.co.uk

CONTENTS



Warnings	3
Environmental Protection	8
Opening the Panel	10
Installation	11
Remote Control	14
Timing	18
Cleaning and Maintenance	19
Caple Contact Details	22

WARNING

The appliance is not intended for use by young children or infirm persons without supervision. Young children should be supervised to ensure they do not play with the appliance.

The extracted air can't be conveyed through or into a duct used to let out fumes from appliances fed by energy other than electric power (eg. centralized heating, radiators, water heaters, etc.).

To evacuate the air outlet, please comply with the pertaining rules given by competent authorities.

- Provide the room with an adequate aeration when a cooker hood and appliances fed by energy other than electric power (gas, oil, or coal stoves, etc.) are used simultaneously.
- The cooker hood, when evacuating the extracted air, could generate a negative pressure in the room which can't exceed the limit of 0.04 mbar, in order to avoid the suck of exhausts deriving from the heat source. Therefore the room should be provided with air-intakes to allow a constant flow of fresh air.
- If the rating label in the cooker-hood does show the symbol  the appliance is built in class 11° and it does not need the earth connection. If the rating label in the cooker hood does not show the symbol , the appliance is built in class I° and it needs the earth connection.
- When performing the electrical connections on the appliance, please make sure that the current tap is provided with earth connection and that voltage values correspond to those indicated on the label placed inside the appliance itself.
- Before carrying out any cleaning or maintaining operations, the appliance needs to be removed from the electric grid.

- If the appliance is not provided with a non-separable flexible cable and plug, or with another device ensuring omnipolar disconnections from the grid, with an opening distance between the contacts of at least 3 mm, then such disconnecting devices must be supplied within the fixed installation.
- If the appliance is endowed with a supply cord and a plug, the appliance has to be put in a place where the plug can be reached easily.
- The use of materials which can burst into flames should be avoided in close proximity of the appliance
- When frying, please pay particular attention to fire risk due to oil grease. Being highly inflammable, fried oil is especially dangerous.
- Do not use uncovered electric grills. In order to avoid possible fire risk, all instructions for grease filter cleaning and for removing eventual grease deposits should be strictly followed.
- This appliance complies with all relevant local and national safety requirements. Inappropriate use can, however, lead to personal injury and damage to property.
- The cooker hood is not intended for outdoor use.
- It must only be used as a domestic appliance to extract vapours and remove odours from cooking. Any other usage is not supported by the manufacturer and could be dangerous.

- Where a recirculation cooker hood is fitted above a gas hob, please ensure that there is an adequate supply of fresh air into the room in which it is installed. Please seek the advice of a qualified gas fitter (e.g. GasSafe in the UK) if necessary.
- Children under 8 years of age must be kept away from the cooker hood unless they are constantly supervised.
- Children 8 years and older may only use the cooker hood unsupervised if they have been shown how to use it safely and recognise and understand the consequences of incorrect operation.
- The electrical safety of this appliance can only be guaranteed when correctly earthed. It is essential that this standard safety requirement is met. If in any doubt please have the electrical installation tested by a qualified electrician.
- Do not connect the appliance to the mains electricity supply by a multi-socket unit or an extension lead. These are a fire hazard and do not guarantee the required safety of the appliance.
- The cooker hood can get very hot during cooking due to heat rising from the hob.
- Do not touch the housing or the grease filters until the cooker hood has cooled down.

APPROPRIATE USE:

- This appliance is intended to be used in household and similar applications such as:
 - › Staff kitchen areas in shops, offices and other working environments.
 - › Farm Houses.
 - › By clients in hotels, motels and other residential type environments.
 - › Bed and breakfast type environments.



ENVIRONMENTAL PROTECTION

Waste electrical products should not be disposed of with household waste. Please recycle where facilities exist. Check with your Local Authority or retailer for recycling advice. This appliance is marked according to the European directive on Waste Electrical and Electronic Equipment (WEEE).

By ensuring this product is disposed of correctly, you will help prevent potential negative consequences for the environment and human health, which could otherwise be caused by inappropriate waste handling of this product. The symbol on the product indicates that this product may not be treated as household waste. Instead it shall be handed over to the applicable collection point for the recycling of electrical and electronic equipment. Disposal must be carried out in accordance with local environmental regulations for waste disposal.

For more detailed information about treatment, recovery and recycling of this product, please contact your local council, your household waste disposal service or the retailer where you purchased the product.

WARRANTY

Your new appliance is covered by warranty. The warranty card is enclosed - if it is missing, you must provide the following information to your retailer in order to receive a replacement: date of purchase, model and serial number. Registration can also be completed online by visiting www.caple.co.uk.

Ensure you keep your warranty card safe, you may need to show it to Caple Service together with proof of purchase. If you fail to show your warranty card you will incur all repair charges.

Spare parts are only available from Caple Service and spare parts authorised centres.

CE DECLARATIONS OF CONFORMITY

Radio Equipment Directive (RED) 2014/53/EU.

This Declaration is issued under the sole responsibility of the manufacturer.

Hereby, Caple declares that the radio equipment included in the product is in compliance with the RED directive 2014/53/EU.

The full text of the EU Declaration of Conformity is available on our website www.caple.co.uk.

UKCA DECLARATIONS OF CONFORMITY

This appliance has been manufactured to the strictest standards and complies with all applicable legislation.

TECHNICAL FICHE

This appliance conforms to all current and applicable energy regulations. To view the Technical Fiche that supports the energy labelling data, please visit the product page on our website www.caple.co.uk

OPENING THE PANEL

It is possible to open the steel panels, which cover the grease filters, by pulling the side of them gently as shown in Fig.1. To achieve the complete opening of the panels, you need to release the safety chains by using the appropriate spring catches.

To work correctly, it is recommended to install the product at a maximum distance of 2000-2100mm, from the floor level.

Before proceeding with the installation of the appliance, check that all the components are not damaged, otherwise please contact your retailer and do not continue with the installation.

Use an air outlet pipe with a maximum length of no more than 5 metres. Reduce the number of bends in the duct as each bend reduces the suction efficiency equivalent to 1 linear meter.

(E.g. If 2 90° bends are used, the length of the duct should not exceed 3 meters in length).

Avoid abrupt changes of direction.

Use a duct with a diameter of 150mm constant over the entire length.

Use a duct of recognised and approved material.

For more information on venting, please see our 'Extraction & Ventilation guide' available at www.caple.co.uk

The cooker hood should be placed at a minimum distance of 65cm above the hob. It is the manufacturer of the hob who determines the clearance required and the clearance quoted by the hob manufacturer must be followed. In the absence of any instructions supplied with a gas hob the minimum distance between the hob and the hood must be at least 760mm.

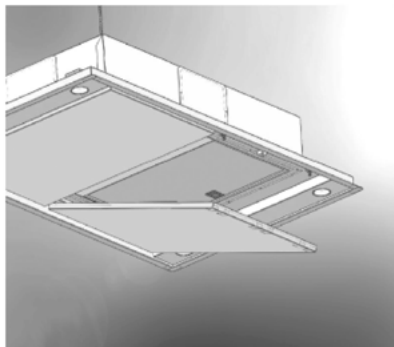

FIG.1

INSTALLATION

Fit a false ceiling with an opening of 865 x 405mm with a minimum distance of 270mm between the ceiling and the false ceiling.

It is possible to select the side of the hood where the extracted air can be discharged. After choosing the most suitable position, prepare the ducting. An air outlet connection piece, with a diameter of 150mm is provided with the appliance. Install the connection piece to the selected side.

Leave any unused exhaust outlets closed.

Draw the outline of the hole to house the ceiling mounted hood on the solid ceiling (Fig.2).

Make 4 holes in the ceiling according to the dimensions shown in (Fig.3). Place the metric plugs provided in the holes.

Open the stainless steel panels, following the instructions in 'Opening the Panels' and remove the grease filters in order to avoid damaging them and to allow installation.

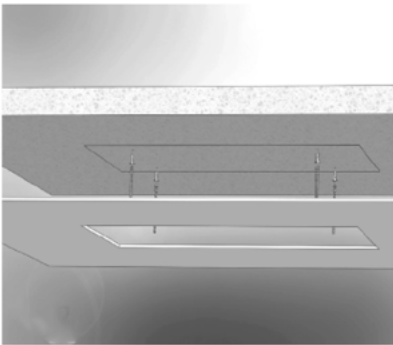

FIG.2

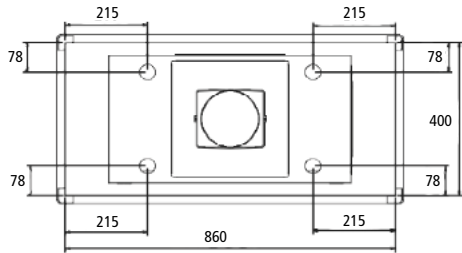

FIG.3

Open the stainless steel panels, following the instructions in 'Opening the Panels' and remove the grease filters in order to avoid damaging them and to allow installation.

Screw the threaded bars provided into the plugs (Fig.4); the threaded bars are 250mm long and serve to install the ceiling mounted hood at a distance from the solid ceiling of between 270mm and 370mm (Fig.5).

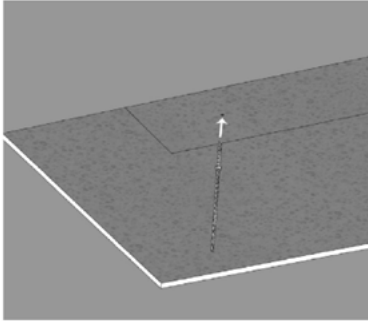

FIG.4

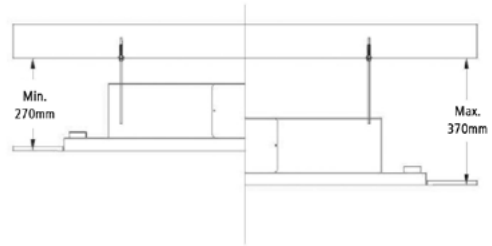

FIG.5

If the hood is installed with a lateral air outlet, fit a false ceiling with an opening that has a minimum gap of 210mm between the ceiling and the false ceiling (Fig.6); in case of a larger gap between the hood and the ceiling, you need to use longer threaded bars.

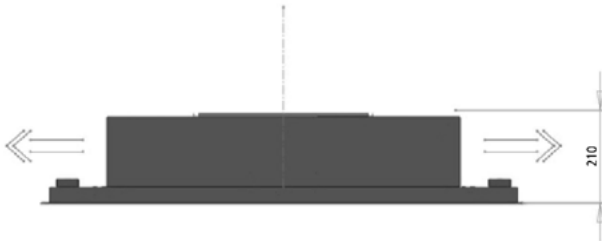

FIG.6

Make the electrical connections and connect the air outlet pipe.

Place the ceiling-mounted hood into the niche, by inserting the threaded bars into the holes (Fig.7). The outer edge of the hood needs to be perfectly flush with the false ceiling.

Insert the plates and nuts provided into the threaded bars, making sure to tighten them securely (Fig.8); refit the grease filters and filter cover panels.

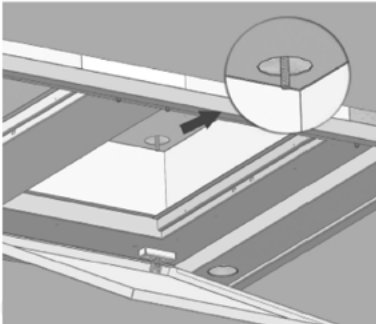

FIG.7

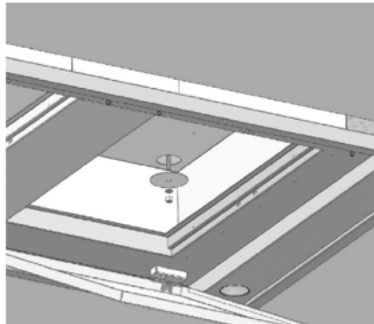

FIG.8

Connect the internal motor or the external motor's cable to the terminal board found inside the plastic box of the wiring. The cables are colour coded, ensure you respect the cables colours when performing the electrical connection (Fig.9).

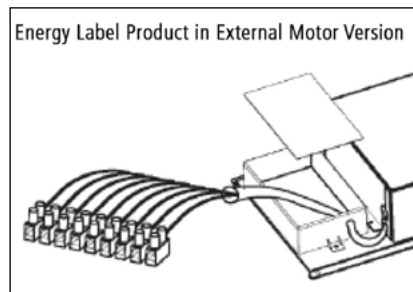
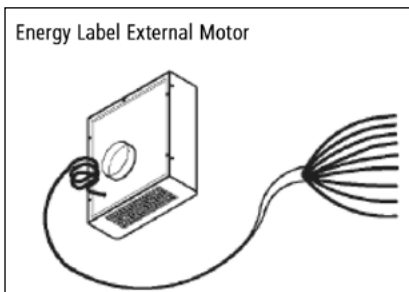

FIG.9

REMOTE CONTROL





Remote control used for the remote operation of Caple hoods:

TECHNICAL DATA

Alkaline battery powered:	12V mod. 27A
Operating frequency:	433.92 Mhz
Combinations:	32.768
Max. consumption:	25 mA
Operating temperature:	-20 ÷ + 55 °C
Dimensions:	120 x 45 x 15 mm

OPERATION

The remote is equipped with 5 buttons for cooker hood management, as specified below:

-  Light ON/OFF command.
-  Motor ON (speed level 1) / OFF command.
-  Reduce speed.
-  Increase speed.
-  10-minute timer.

INITIAL OPERATING CONDITION

The manufacturer supplies the control unit ready to be used with preset codes.

STANDARD CONFIGURATION:

Standard configuration requires all cooker hood remote controls to be provided with the same transmission code. In the event two cooker hoods radio control system are installed in the same room or nearby, each system may affect the operation of the another. Therefore, the code of one radio control system must be changed.

GENERATING A NEW TRANSMISSION CODE:

The remote control system is provided with preset codes. Should new codes be required, proceed as follows: Simultaneously press buttons:



for two seconds. When LED's light on, press buttons:



(within 5 seconds). LED's flashing 3 times indicate the procedure is completed.

WARNING:

This operation permanently deletes the preset codes.

LEARNING THE NEW TRANSMISSION CODE

Once the transmission code is changed in the remote control unit, the electronic central unit of the cooker hood must be made to set the new code in the following way:

Press the main power-off button on the hood (fig.10) and then restore power to the electronic control unit. Within the next 15 seconds, press the Light Button to synchronise the central unit with the code.

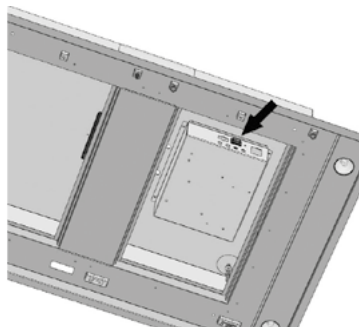

FIG.10

DIMMABLE LIGHTS FUNCTION

This function provides for lights dimmability, ranging from 20% to 100%, by continuously pressing the light key on the remote control.

Functions are the following:

- › Hood light off - press the light key - light on at 100%.
- › Light on at 100% - press the light key - light off.
- › Light on at 100% - continuously press the light key - brightness reduction.
- › Releasing the key during reduction or increase - light keeps the luminous intensity reached.
- › Light on - dimmed - continuously press the light key - brightness is inverted if compared to the previous function.

RESET OF THE FACTORY CONFIGURATION:

To restore the Factory configuration, follow the procedure described below: simultaneously press buttons



for 2 seconds. When LED's light on, press buttons



(within 5 seconds). LED's flashing 6 times indicate the procedure is completed.

WARNING:

This operation permanently deletes the preset codes.

EMERGENCY BUTTON:

In the event that the remote control does not work, use the emergency button to switch the appliance off.

After any necessary repairs have been performed, reset the emergency button.

WARNING:

The battery should be replaced every year to guarantee the optimal range of the transmitter. To replace the battery, take the plastic lid off, remove the battery and replace it with a new one, observing the correct battery polarities. Used batteries should be discarded in special collection bins.

WARNING:

Any adjustments or modifications which have not been expressly approved by the holder of the legal conformity certificate may invalidate the user's rights relating to the operation of the device.

The products are endowed with an electronic device which automatically switches the product off after 4 hours working from the last operation.

TIMING

- › This product is equipped with intelligent electronics which include a timer device for speed controls when the air capacity exceeds 650m³/h. Internal motor models, with maximum air capacity higher than 650m³/h, are equipped with a timer device that automatically switches the speed from 4th to 3rd speed, after 5 minutes operation.
- › External motor models are equipped with remote motors that, as for internal motor versions, include a timer device that switches down the speed when it exceeds 650 m³/h. (See External Motors Instructions). Remote motors, whose air capacity exceeds 650m³/h at both 4th and 3rd speed, will have the following by default timer control functions: The speed is automatically switched from 4th to 2nd speed, after 6 minutes operation.
- › If the appliance is working at 3rd speed, it is automatically switched to 2nd speed, after 7 minutes operation. Operation speeds can also be changed during operation. The energy consumption of the appliance in standby mode is lower than 0.5W.

CLEANING AND MAINTENANCE

Careful maintenance ensures smooth operation and long-lasting performance. Special care must be taken with the grease filter. To access the filter, open the glass panels by gently pulling the side of the panel as shown in figure 11. Remove the grease filter by pulling its handle. To replace the grease filter after cleaning, fulfil the same operation in reverse order.

ATTENTION:

After refastening the stainless steel panel make sure that it is properly fixed.

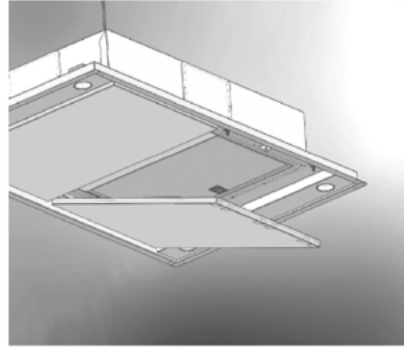

FIG.11

Warm water and neutral detergents are recommended to clean the appliance, while abrasive products should be avoided. Once cleaned, dry with a soft cloth. For steel appliances specialised detergents are recommended (please follow the instructions mentioned on the product itself to obtain the desired results).

REPLACING LED LIGHTING

LIGHT SOURCE ENERGY CLASS

This product contains a light source of energy efficiency class F.

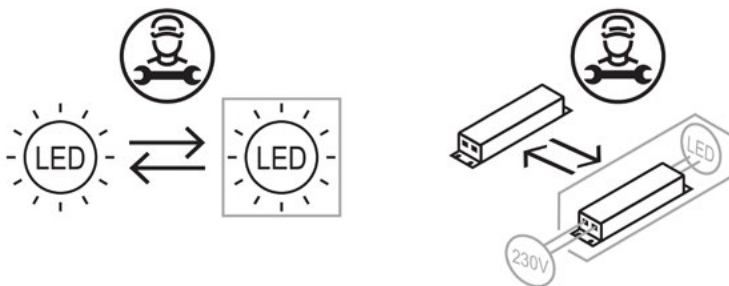

The LED light must be replaced by an authorised engineer or similar only. For more information, please contact Caple service - 0117 938 7420 or service@caple.co.uk



Unplug the unit from the power supply before starting the process.

1. Carefully insert a flat screw driver into the edge of the LED light.
2. Remove the LED light from its housing.
3. Disconnect the connector and change the LED light.
4. Implement the steps in reverse order.
5. After waiting 5 minutes, plug in the unit.

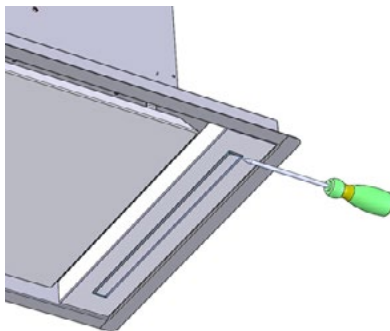



Caple Service
Fourth Way
Avonmouth
Bristol
BS11 8DW

T: 0117 938 1900
E: service@caple.co.uk
www.caple.co.uk