



# Ceramic Hob Instruction Manual

## C816C



Contact Caple on 0117 938 7420 for spare parts or [www.caple.co.uk](http://www.caple.co.uk)

## CONTENTS

---

Safety Instructions	3
Environmental Protection	9
Technical Fiche	10
Product Description	11
Control Panel	12
Before Using Your New Ceramic Hob	13
Using your Ceramic Hob	15
Cooking Guidelines	19
Installation	21
Cleaning and Maintenance	25
Troubleshooting	26
Technical Specification	27
Caple Contact Details	28

Congratulations on the purchase of your new Caple hob.

We recommend that you spend some time reading this instruction manual in order to fully understand how to correctly install and operate your hob. For installation, please read the installation section. Read all the safety instructions carefully before using your hob and keep this instruction manual for future reference.

## **SAFETY INSTRUCTIONS**

Your safety is important to us. Please read this information before using your hob.

## **INSTALLATION WARNINGS**

### **ELECTRICAL SHOCK HAZARD**

- Disconnect the appliance from the mains electricity supply before carrying out any work or maintenance on it.
- Connection to a good earth wiring system is mandatory.
- Alterations to the domestic wiring system must only be made by a qualified electrician.
- Failure to follow this advice could be fatal or seriously injure the user.

### **CUT HAZARD**

- Take care, panel edges are sharp. Failure to do so may result in injury or cuts.

## IMPORTANT SAFETY INSTRUCTIONS

- Read these instructions carefully before installing or using this appliance.
- No combustible materials or products should be placed on this appliance at any time.
- Please make this information available to the person responsible for installing the appliance.
- In order to avoid a hazard, this appliance must be installed according to these instructions.
- This appliance is to be installed correctly and earthed only by a suitably qualified person.
- This appliance should be connected to a circuit which incorporates an isolating switch providing full disconnection from the power supply.
- Failure to install the appliance correctly could invalidate any warranty or liability claims.

## OPERATION AND MAINTENANCE WARNINGS

### ELECTRICAL SHOCK HAZARD

- Do not cook on a broken or cracked hob. If the hob surface should break or crack, switch the appliance off immediately at the main power supply (wall switch) and contact a qualified technician.

- Switch the hob off at the wall before cleaning or maintenance.
- Failure to follow this advice could be fatal or seriously injure user.
- This appliance complies with electromagnetic safety standards.

## **HOT SURFACE HAZARD**

- During use, accessible parts of this appliance will become hot enough to cause burns.
- Do not let your body, clothing or any item other than suitable cookware contact the ceramic glass until the surface is cool.
- Metallic objects such as knives, forks, spoons and lids should not be placed on the hob surface.
- Keep children away from appliance.
- Handles of saucepans may be hot to touch. Check saucepan handles do not overhang other cooking zones that are on. Keep handles out of reach of children.
- Failure to follow this advice could result in burns and scalds.

## **IMPORTANT SAFETY INSTRUCTIONS**

- Never leave the appliance unattended when in use as pans may boil over which may result in smoking or grease spills that may ignite.
- Never use your appliance as a work or storage surface.
- Never leave any objects or utensils on the appliance.
- Never use your appliance for warming or heating the room.
- After use, always turn off the cooking zones and the hob as described in this manual.
- Do not allow children to play, sit, stand, or climb on the appliance.
- Do not store children's toys in cabinets above the appliance to avoid the risk of children climbing on the hob as this could result in serious injury.
- Do not leave children alone or unattended in the kitchen when the hob is in use.
- Persons with reduced physical, sensory or mental capabilities or lack of experience and knowledge must be supervised and given appropriate instruction concerning the use of the appliance in a safe way and understand the hazards involved.
- Do not repair or replace any part of the appliance unless specific instructions are detailed in the manual. All other servicing should be done by a qualified technician.

- Do not use a steam cleaner to clean the hob.
- Do not place or drop heavy objects on your hob.
- Do not stand on your hob.
- Do not use pans with jagged edges or drag pans across the surface as this can scratch the glass.
- Do not use scourers or any other harsh abrasive cleaning agents to clean your hob, as these can scratch glass.
- If the supply cord is damaged, it must be replaced by Caple service or similarly qualified persons in order to avoid a hazard.
- This appliance is intended to be used in household and similar applications such as:
  - › Staff kitchen areas in shops, offices and other working environments.
  - › Farm Houses.
  - › By clients in hotels, motels and other residential type environments.
  - › Bed and breakfast type environments.

## **WARNING:**

- **WARNING:** The appliance and its accessible parts become hot during use.
- Care should be taken to avoid touching heating elements.
- Children less than 8 years of age shall be kept away unless continuously supervised.

- This appliance can be used by children aged from 8 years and above and persons with reduced physical, sensory or mental capabilities or lack of experience and knowledge if they have been given supervision or instruction concerning use of the appliance in a safe way and understand the hazards involved.
- Children should not play with the appliance.
- Cleaning and user maintenance should not be carried out by children without supervision.
- **WARNING:** Unattended cooking on a hob with fat or oil can be dangerous and may result in fire. **NEVER** try to extinguish a fire with water, but switch off the appliance and then cover flame e.g. with a lid or a fire blanket.
- **WARNING:** Danger of fire: do not store items on the cooking surfaces.
- **WARNING:** If the glass/ceramic surface is cracked it can expose live parts, switch off the appliance to avoid the possibility of electric shock.
- Do not steam clean.
- The appliance is not intended to be operated by means of an external timer or separate remote control system.





## ENVIRONMENTAL PROTECTION

Waste electrical products should not be disposed of with household waste. Please recycle where facilities exist. Check with your Local Authority or retailer for recycling advice. This appliance is marked according to the European directive on Waste Electrical and Electronic Equipment (WEEE). By ensuring this product is disposed of correctly, you will help prevent potential negative consequences for the environment and human health, which could otherwise be caused by inappropriate waste handling of this product. The symbol on the product indicates that this product may not be treated as household waste. Instead it shall be handed over to the applicable collection point for the recycling of electrical and electronic equipment. Disposal must be carried out in accordance with local environmental regulations for waste disposal. For more detailed information about treatment, recovery and recycling of this product, please contact your local council, your household waste disposal service or the retailer where you purchased the product.

## CE DECLARATIONS OF CONFORMITY



This appliance has been manufactured to the strictest standards and complies with all applicable legislation, Low Voltage Directive (LVD) and Electromagnetic Compatibility (EMC).

## UKCA DECLARATIONS OF CONFORMITY



This appliance has been manufactured to the strictest standards and complies with all applicable legislation.

## TECHNICAL FICHE

This appliance conforms to all current and applicable energy regulations. To view the Technical Fiche that supports the energy labelling data, please visit the product page on our website [www.caple.co.uk](http://www.caple.co.uk)

## WARRANTY

Your new appliance is covered by warranty. The warranty card is enclosed - if it is missing, you must provide the following information to your retailer in order to receive a replacement: date of purchase, model and serial number. Registration can also be completed online by visiting

**[www.caple.co.uk](http://www.caple.co.uk)**.

Ensure you keep your warranty card safe, you may need to show it to Caple Service together with proof of purchase.

If you fail to show your warranty card you will incur all repair charges. Spare parts are only available from Caple Service and spare parts authorised centres.

## PRODUCT DESCRIPTION

---

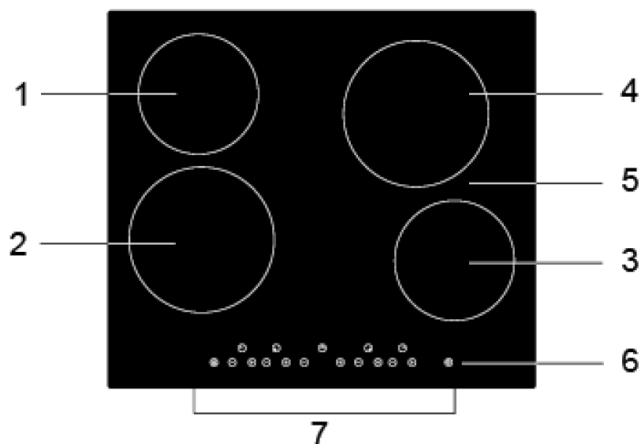

1. Max. 1200W zone
2. Max. 1800W zone
3. Max. 1200W zone
4. Max. 1800W zone
5. Ceramic glass top
6. ON / OFF
7. Control panel

## CONTROL PANEL

---

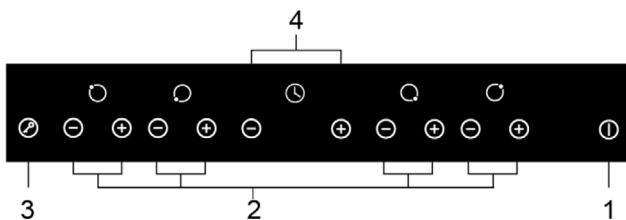

1. ON/OFF control
2. Power controls
3. Keylock control
4. Timer controls

### WORKING PRINCIPLE

This ceramic hob directly applies resistance wire heating to the bottom of the pan.

The power output can be adjusted using the power controls on the control panel.

Refer to the 'USING YOUR CERAMIC HOB' section, page 14.

## BEFORE USING YOUR NEW CERAMIC HOB

---

- › Read this guide, taking special note of the 'Safety Warnings' section.
- › Remove any protective film that may still be on your ceramic hob.

### USING THE TOUCH CONTROLS

- › The controls respond to touch, so you don't need to apply any pressure.
- › Use the ball of your finger, not its tip.
- › You will hear a beep each time a touch is registered.
- › Make sure the controls are always clean, dry, and that there is no object (e.g. a utensil or a cloth) covering them. Even a thin film of water may make the controls difficult to operate.

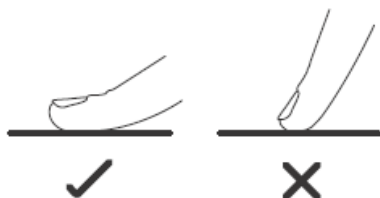

## CHOOSING THE RIGHT COOKWARE

Do not use cookware with jagged edges or a curved base.



Make sure that the base of your pan is smooth, sits flat against the glass, and is the same size as the cooking zone. Always centre your pan on the cooking zone.

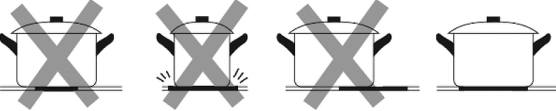

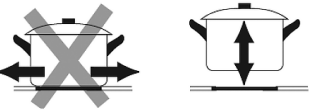

Always lift pan off the ceramic hob – do not slide them or they may scratch the glass.





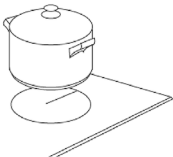

# USING YOUR CERAMIC HOB

## TO START COOKING

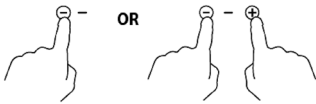
	<p>When power to the hob is turned on the buzzer sounds once, all the indicators light up for 1 second then go out, indicating that the ceramic hob has entered standby mode.</p> <p>To turn on, touch the ON/OFF control ①. All the indicators then show “-”.</p>
	<p>Place a suitable pan on the cooking zone that you wish to use.</p> <p>Make sure both the bottom of the pan and the surface of the cooking zone are clean and dry.</p>
	<p>Select a heat setting by touching the ⊖ or ⊕ controls.</p> <ul style="list-style-type: none"><li>- If you do not choose a heat setting within 1 minute, the ceramic hob will automatically switch off. You will need to start again at step 1.</li><li>- You can modify the heat setting at any time during cooking.</li></ul>

## WHEN YOU HAVE FINISHED COOKING

	<p>Turn the cooking zone off by scrolling down to “-” or touching ⊖ and ⊕ together.</p>
	<p>You can turn the whole hob off by touching the ON/OFF control.</p>
	<p> <b>BEWARE OF HOT SURFACES</b></p> <p>“H” will show which cooking zone is hot to touch. It will disappear when the surface has cooled down to a safe temperature. It can also be used as an energy saving function. If you want to heat further pans, use the zone that is still hot.</p>

## LOCKING THE CONTROLS

- › You can lock the controls to prevent unintended use (for example children accidentally turning the cooking zones on).
- ›  When the controls are locked, all the controls except the ON/OFF control are disabled. In the event of an emergency, you can always turn the hob off by using the ON/OFF button.

### TO LOCK THE CONTROLS



Touch the lock control, the timer will then display 'Lo'

### TO UNLOCK THE CONTROLS



Make sure the hob is turned on.  
Touch and hold the keylock control  for 5 seconds.

## OVER-TEMPERATURE PROTECTION

A temperature sensor monitors the temperature inside the hob. When an excessive temperature is sensed, the hob will automatically stop the operation.

## RESIDUAL HEAT WARNING

When the hob has been operating for some time, there will be some residual heat. The letter "H" appears to warn you not to touch the cooking zones.

## AUTO SHUTDOWN PROTECTION

Another safety feature of the hob is auto shutdown. This occurs whenever you forget to switch off a cooking zone. The default shutdown times are shown in the table below:





Power level	1	2	3	4	5	6	7	8	9
Default working time (hours)	8	8	8	4	4	4	2	2	2



## TIMER CONTROL



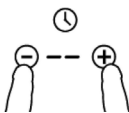

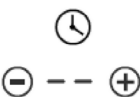
You can use the timer in two different ways:

- › You can use it as a minute minder. In this case, the timer will not turn any cooking zone off when the set time is up.
- › You can set it to turn one or more cooking zones off after the set time is up.  
The timer maximum is 99 minutes.

Using the timer as a minute minder, when you are not selecting any cooking zone	
	Make sure the hob is turned on. Note: you can use the minute minder even if you're not selecting any cooking zone.
	Touch the ⊖ or ⊕ controls of the timer. The minute minder indicator will flash.
	Set the time by touching the ⊖ or ⊕ control of the timer: Touch the ⊖ or ⊕ control of the timer once to decrease or increase the time by 1 minute.
	Touch and hold the ⊖ or ⊕ control of the timer to decrease or increase the time by 10 minutes. If the setting time exceeds 99 minutes, the timer will automatically return to 0.
	If you touch the ⊖ and ⊕ together, the timer will be cancelled, and "--" will show in the minute display. When the time is set, it will begin to count down immediately. The display will show the remaining time and the timer indicator will flash for 5 seconds.
	A buzzer will sound for 30 seconds and the timer indicator shows "--" when the set time has finished.

## SETTING THE TIMER TO TURN ONE OR MORE COOKING ZONES OFF

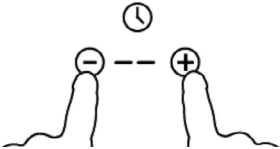
### USING THE TIMER AS A MINUTE MINDER, WHEN YOU ARE NOT SELECTING ANY COOKING ZONE

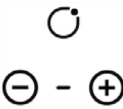
	<p>Touch the <math>\ominus</math> or <math>\oplus</math> power setting for the corresponding cooking zone you want to set the timer for.</p>
	<p>Set the time by touching the control for the timer</p> <p>If you touch the <math>\ominus</math> or <math>\oplus</math> control of the timer once, the time will decrease or increase by 1 minute.</p> <p>If you touch the <math>\ominus</math> and <math>\oplus</math> together, this will cancel the timer and it will display "--" in the minute display.</p>
	<p>If you touch the <math>\ominus</math> and <math>\oplus</math> together, this will cancel the timer and it will display "--" in the minute display.</p>
	<p>When the time is set, it will begin to count down immediately. The display will show the remaining time and the timer indicator will flash for 5 seconds.</p>
	<p>The red dot next to the power level indicator will illuminate, indicating that zone is selected.</p>
	<p>When the cooking timer expires, the corresponding cooking zone will switch off automatically.</p>

#### NOTE:

If you want to change the time after the timer is set, you have to start from step 1.

## COOKING GUIDELINES

---

 Take care when frying as the oil and fat heat up very quickly, particularly if you're using the Boost function. At extremely high temperatures oil and fat will ignite spontaneously and this presents a serious fire risk.

- › When food comes to the boil, reduce the temperature setting.
- › Using a lid will reduce cooking times and save energy by retaining the heat.
- › Minimise the amount of liquid or fat to reduce cooking times.
- › Start cooking on a high setting and reduce the setting when the food has heated through.

### **SIMMERING**

- › Simmering occurs below boiling point, at around 85°C, when bubbles are just rising occasionally to the surface of the cooking liquid. This is the key to delicious soups and tender stews because the flavours develop without the food being overcooked. Also, you should cook egg-based and flour thickened sauces below boiling point.
- › Some tasks, including cooking rice by the absorption method, may require a setting higher than the lowest setting to ensure the food is cooked properly in the time recommended.

### **SEARING STEAK**

To cook juicy, flavoursome steaks:

1. Stand the meat at room temperature for about 20 minutes before cooking.
2. Heat up a heavy-based frying pan.
3. Brush both sides of the steak with oil. Drizzle a small amount of oil into the hot pan and then lower the meat onto the hot pan.
4. Turn the steak only once during cooking. The exact cooking time will depend on the thickness of the steak and how you want it cooked. Times may vary from about 2 - 8 minutes per side. Press the steak to gauge how cooked it is - the firmer it feels the more 'well done' it will be.
5. Leave the steak to rest on a warm plate for a few minutes to allow it to relax and become tender before serving.

## STIR-FRYING

1. Choose a compatible flat-based wok or a large frying pan.
2. Have all the ingredients and equipment ready. Stir-frying should be quick. If cooking large quantities, cook the food in several smaller batches.
3. Preheat the pan briefly and add two tablespoons of oil.
4. Cook any meat first, put it aside and keep warm.
5. Stir-fry the vegetables. When they are hot but still crisp, turn the cooking zone to a lower setting, return the meat to the pan and add your sauce.
6. Stir the ingredients gently to make sure they are heated through.
7. Serve immediately.

## HEAT SETTINGS

The settings below are guidelines only. The exact setting will depend on several factors, including your cookware and the amount you are cooking. Experiment with the hob to find the settings that best suit you.

HEAT SETTING	SUITABILITY
1-2	Delicate warming for small amounts of food Melting chocolate, butter, and foods that burn quickly Gentle simmering Slow warming
3-4	Reheating Rapid simmering Cooking rice
5-6	Pancakes
7-8	Saut�eing Pasta
9	Stir-frying Searing Bringing soup to the boil Boiling water

## INSTALLATION

Cut out the work surface according to the sizes shown in the drawing. For the purpose of installation and use, a minimum of 50mm space must be left around the hole. Be sure the thickness of the work surface is at least 30mm. Please select heat-resistant work surface material to avoid deformation caused by the heat radiation from the hob. See below:

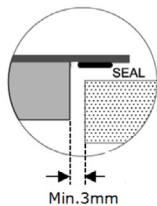
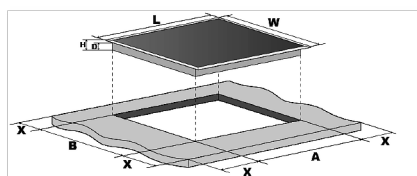

L (mm)	W (mm)	H (mm)	D (mm)	A (mm)	B (mm)	X (mm)
590	520	55	51	564	494	50 (min)

### WARNING:

Always ensure the hob is well ventilated and the air inlet and outlet are not blocked. Ensure the ceramic hob is in good working order. See below:

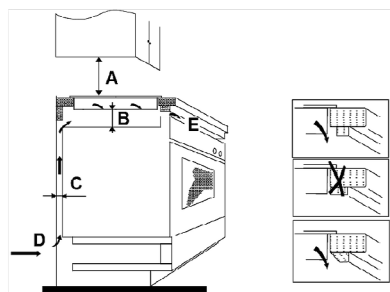

A (mm)	B (mm)	C (mm)	D	E
760	50 (min)	20 (min)	Air intake	Air exit (5mm)



### NOTE:

For safety, the distance between the hob and the cupboard above should be at least 760mm.

There are ventilation holes around the outside of the hob. YOU MUST ensure these holes are not blocked by the worktop when you place the hob in position.

The rear wall, adjacent and surrounding surfaces must be able to withstand an temperature of 90°C.

## BEFORE INSTALLING THE HOB

---

- › The ceramic hob must be installed by qualified personnel or technicians. Please never conduct the installation by yourself.
- › Check the work surface is square and level, and no structural parts interfere with the space requirements.
- › Ensure the work surface is made of a heat-resistant material.
- › If the hob is installed above an oven, check the oven has a built-in cooling fan.
- › The installation must comply with all clearance requirements and applicable standards and regulations.
- › Ensure a suitable isolating switch providing full disconnection from the mains power supply is incorporated in the permanent wiring, mounted and positioned to comply with the local wiring rules and regulations.
- › The isolating switch must be of an approved type and provide a 3mm air gap contact separation in all poles (or in all active [phase] conductors if the local wiring rules allow for this variation of the requirements).
- › The isolating switch must be easily accessible to the customer once the hob is installed.
- › Consult local building authorities and by-laws if in doubt regarding installation.
- › Use heat-resistant and easy-to-clean finishes (such as ceramic tiles) for the wall surfaces.

### **AFTER INSTALLING THE HOB**

- › Ensure the power supply cable is not accessible through cupboard doors or drawers.
- › Ensure there is an adequate flow of fresh air from outside the cabinetry to the base of the hob.
- › If the hob is installed above a drawer or cupboard space, a thermal protection barrier is installed below the base of the hob.
- › The isolating switch must be easily accessible by the customer.

### **BEFORE LOCATING THE FIXING BRACKETS**

- › The unit should be placed on a stable, smooth surface (use the packaging).  
Do not apply force onto any controls protruding from the hob.

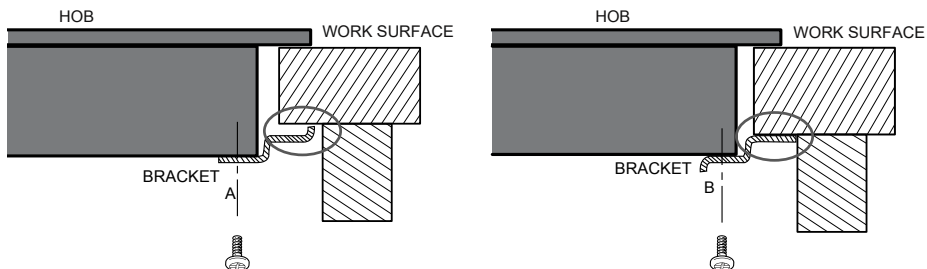

**⚠** Under any circumstances, the brackets cannot touch with the inner surfaces of the worktop after installation (see picture). This will ensure the hob is properly secured to the underside of the work surface.

**CAUTIONS:**

- › The ceramic hob should not be mounted next to cooling equipment, dishwashers and rotary dryers.
- › The wall and cooking zone above the work surface must withstand heat.
- › To avoid any damage, the worktop sandwich layer and adhesive must be heat resistant.

## CONNECTING THE HOB TO THE MAINS POWER SUPPLY

### WARNING:

The power supply should be connected in compliance with the relevant standard, or a single-pole circuit breaker. The method of connection is shown below.

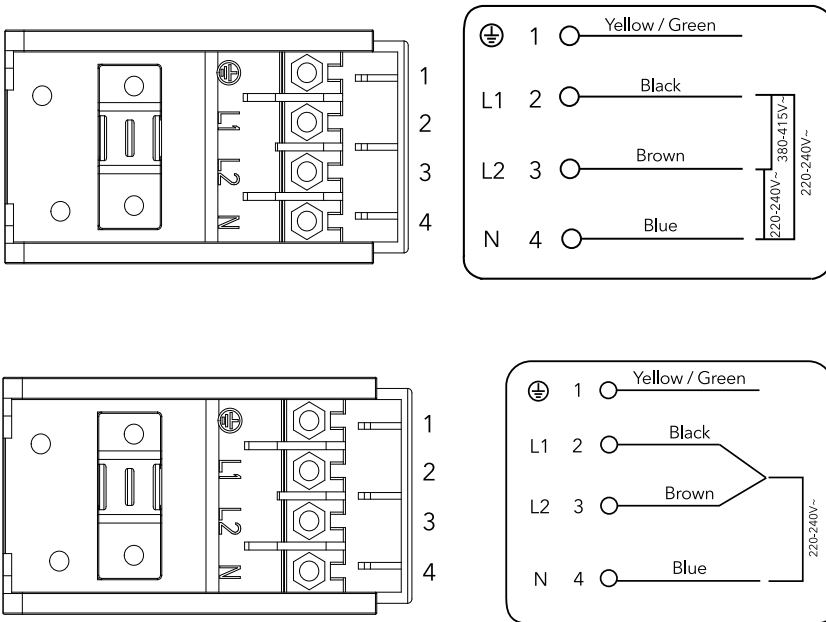

- › If the cable is damaged or needs replacing, this should be done by an after-sales technician using the correct tools.
- › If the appliance is being connected directly to the mains supply, an omnipolar circuit breaker must be installed with a minimum gap of 3mm between the contacts.
- › The installer must ensure that the correct electrical connection has been made and that it complies with safety regulations.
- › The cable must not be bent or compressed.
- › The cable must be checked regularly and replaced by authorised technicians only.
- ⚠ The bottom surface and the power cord of the hob are not accessible after installation.



## CLEANING AND MAINTENANCE

WHAT?	HOW?	IMPORTANT
Everyday soiling on glass (fingerprints, marks, stains left by food or non-sugary spillovers on the glass).	<ol style="list-style-type: none"> <li>1. Switch the power to the hob off.</li> <li>2. Apply a hob cleaner while the glass is still warm (but not hot!).</li> <li>3. Rinse and wipe dry with a clean cloth or paper towel.</li> <li>4. Switch the power to the hob back on.</li> </ol>	<ul style="list-style-type: none"> <li>- When the power to the hob is switched off, there will be no "hot surface" indication but the cooking zone may still be hot! Take extreme care.</li> <li>- Heavy-duty scourers, some nylon scourers and harsh/abrasive cleaning agents may scratch the glass. Always read the label to check whether your cleaner or scourer is suitable.</li> <li>- Never leave cleaning residue on the hob as the glass may become stained.</li> </ul>
Boilovers, melts, and hot sugary spills on the glass.	<p>Remove these immediately with a fish slice, palette knife or razor blade scraper suitable for ceramic glass hobs, but beware of hot cooking zone surfaces:</p> <ol style="list-style-type: none"> <li>1. Switch the power to the hob off at the wall.</li> <li>2. Hold the blade or utensil at a 30° angle and scrape the soiling or spill over to a cool area of the hob.</li> <li>3. Clean the soiling or spill up with a dish cloth or paper towel.</li> <li>4. Follow steps 2 to 4 for 'Everyday soiling on glass' above.</li> </ol>	<p>Remove melts and sugary food or spillovers as soon as possible. If left to cool on the glass, they may be difficult to remove or may even permanently damage the glass surface.</p> <p>Cut hazard: when the safety cover is retracted, the blade in a scraper is razor-sharp. Use with extreme care and always store safely and out of reach of children.</p>
Spillovers on the touch controls.	<ol style="list-style-type: none"> <li>1. Switch the power to the hob off.</li> <li>2. Soak up the spill.</li> <li>3. Wipe the touch control area with a clean, damp sponge or cloth.</li> <li>4. Wipe the area completely dry with a paper towel.</li> <li>5. Switch the power back on.</li> </ol>	<p>The hob may beep and turn itself off, and the touch controls may not function while there is liquid on them. Make sure you wipe the touch control area dry before turning the hob back on.</p>

## TROUBLESHOOTING

---

PROBLEM	POSSIBLE CAUSES	WHAT TO DO
The hob cannot be turned on.	No power.	Make sure the hob is connected to the power supply and that it is switched on. Check whether there is a power outage in your home or area. If you've checked everything and the problem persists, contact Caple service.
The touch controls are unresponsive.	The controls are locked.	Unlock the controls. See section 'Using your ceramic cooktop' for instructions.
The touch controls are difficult to operate.	There may be a slight film of water over the controls, or you may be using the tip of your finger when touching the controls.	Make sure the touch control area is dry and use the ball of your finger when touching the controls.
The glass is being scratched.	Rough-edged cookware. Unsuitable, abrasive scourer or cleaning products being used.	Use cookware with a flat and smooth base. See 'Choosing the right cookware'. See 'Cleaning and Maintenance'.
Some pans make crackling or clicking noises.	This may be caused by the construction of your cookware.	This is normal for cookware and does not indicate a fault.

For further information or advice, Caple service can be contacted by telephone

**0117 938 7420** or email **service@caple.co.uk**

## TECHNICAL SPECIFICATION

---

Model code	C816C
Cooking zones	4 zones
Supply voltage	220-240V~ 50/60Hz
Installed electric power	5500-6600W
Product size LxWxH (mm)	590 X 520 X 55
Building in dimensions AxB (mm)	564 X 494

Weight and dimensions are approximate. Because we continually strive to improve our products we may change specifications and designs without prior notice.



Caple Service

Fourth Way

Avonmouth

Bristol

BS11 8DW

T: 0117 938 1900

E: [service@caple.co.uk](mailto:service@caple.co.uk)

[www.caple.co.uk](http://www.caple.co.uk)