

# DIMENSIONS

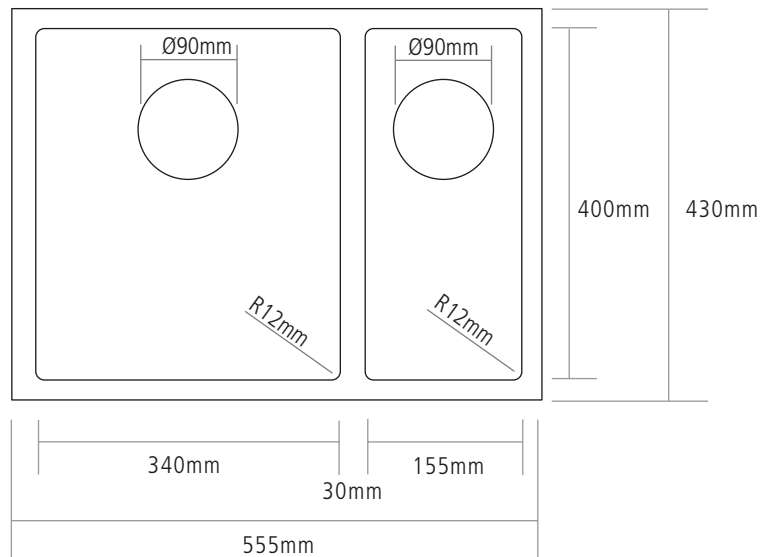

**BOWL DEPTH:** 200MM

**SMALL BOWL DEPTH:** 150MM

**MIN. BASE UNIT:** 600MM

**INSET CUT-OUT SIZE:** 547 X 424MM

**NOTE:** For cut-out shape go to [www.caple.co.uk](http://www.caple.co.uk) for template