



# Ceramica Island Hood Instruction Manual

---

# CR700 CR700SL CR700WH



Contact Caple on 0117 938 7420 for spare parts or [www.caple.co.uk](http://www.caple.co.uk)

## CONTENTS

---

Safety Instructions	3
Environmental Protection	7
Installation	9
Remote Control	14
Timing	17
Cleaning and Maintenance	18
After Sales	21
Caple Contact Details	22

# SAFETY INSTRUCTIONS

## WARNING

- The cooking surface and the inferior part of the cooker hood must be at a minimum distance of 65 cm.
- The appliance is not intended for use by young children or infirm persons without supervision. Young children should be supervised to ensure they do not play with the appliance.
- The cooker hood, when evacuating the extracted air, could generate negative pressure in the room, which can't exceed the limit of 0.04 mbar, in order to avoid the suck of exhausts deriving from the heat-source. Therefore the room should be provided with air-intakes to allow a constant flow of fresh air.
- When performing the electrical connections on the appliance, please make sure that the current tap is provided with earth connection and that voltage values correspond to those indicated on the rating label placed inside the appliance itself.
- Please disconnect the appliance from power mains, before carrying out any cleaning or maintenance operation. If the appliance is not equipped with a nonseparable flexible cable and plug, or with another device ensuring omnipolar disconnection from the mains, with an opening distance between the contacts of at least 3 mm, then such disconnecting devices must be provided in the fixed installation.

- If the appliance is equipped with a power cord and a plug, it shall be placed in such a way that the plug can be reached easily.
- The use of materials which can burst into flames should be avoided in close proximity of the appliance. When frying, please pay particular attention to fire risk due to oil and grease. Being highly inflammable, fried oil is especially dangerous. Do not use uncovered electric grills. In order to avoid possible fire risk, all instructions for grease-filter cleaning and for removing eventual grease deposits should be strictly followed.
- Two persons are needed for the installation of this product.
- This appliance complies with all relevant local and national safety requirements. Inappropriate use can, however, lead to personal injury and damage to property.
- The cooker hood is not intended for outdoor use.
- It must only be used as a domestic appliance to extract vapours and remove odours from cooking. Any other usage is not supported by the manufacturer and could be dangerous.
- Where a recirculation cooker hood is fitted above a gas hob, please ensure that there is an adequate supply of fresh air into the room in which it is installed. Please seek the advice of a qualified gas fitter (e.g. GasSafe in the UK) if necessary.

- Children under 8 years of age must be kept away from the cooker hood unless they are constantly supervised.
- Children 8 years and older may only use the cooker hood unsupervised if they have been shown how to use it safely and recognise and understand the consequences of incorrect operation.
- The electrical safety of this appliance can only be guaranteed when correctly earthed. It is essential that this standard safety requirement is met. If in any doubt please have the electrical installation tested by a qualified electrician.
- Do not connect the appliance to the mains electricity supply by a multi-socket unit or an extension lead. These are a fire hazard and do not guarantee the required safety of the appliance.
- The cooker hood can get very hot during cooking due to heat rising from the hob.
- Do not touch the housing or the grease filters until the cooker hood has cooled down.

## **APPROPRIATE USE:**

- This appliance is intended to be used in household and similar applications such as:
  - › Staff kitchen areas in shops, offices and other working environments.
  - › Farm Houses.
  - › By clients in hotels, motels and other residential type environments.
  - › Bed and breakfast type environments.



## ENVIRONMENTAL PROTECTION

Waste electrical products should not be disposed of with household waste. Please recycle where facilities exist. Check with your Local Authority or retailer for recycling advice. This appliance is marked according to the European directive on Waste Electrical and Electronic Equipment (WEEE).

By ensuring this product is disposed of correctly, you will help prevent potential negative consequences for the environment and human health, which could otherwise be caused by inappropriate waste handling of this product. The symbol on the product indicates that this product may not be treated as household waste. Instead it shall be handed over to the applicable collection point for the recycling of electrical and electronic equipment. Disposal must be carried out in accordance with local environmental regulations for waste disposal.

For more detailed information about treatment, recovery and recycling of this product, please contact your local council, your household waste disposal service or the retailer where you purchased the product.

## WARRANTY

Your new appliance is covered by warranty. The warranty card is enclosed - if it is missing, you must provide the following information to your retailer in order to receive a replacement: date of purchase, model and serial number. Registration can also be completed online by visiting [www.caple.co.uk](http://www.caple.co.uk).

Ensure you keep your warranty card safe, you may need to show it to Caple Service together with proof of purchase. If you fail to show your warranty card you will incur all repair charges.

Spare parts are only available from Caple Service and spare parts authorised centres.

## CE DECLARATIONS OF CONFORMITY



Radio Equipment Directive (RED) 2014/53/EU.

This Declaration is issued under the sole responsibility of the manufacturer.

Hereby, Caple declares that the radio equipment included in the product is in compliance with the RED directive 2014/53/EU.

The full text of the EU Declaration of Conformity is available on our website

[www.caple.co.uk](http://www.caple.co.uk).

## UKCA DECLARATIONS OF CONFORMITY **UK CA**

This appliance has been manufactured to the strictest standards and complies with all applicable legislation.

### **TECHNICAL FICHE**

This appliance conforms to all current and applicable energy regulations. To view the Technical Fiche that supports the energy labelling data, please visit the product page on our website [www.caple.co.uk](http://www.caple.co.uk).



# INSTALLATION

---

This appliance can be used in recirculation mode only. In recirculation mode the air and fumes conveyed by the appliance are cleaned by both a grease filter and an active charcoal filter, and then released back into the room.

Prior to installation, make sure that the packaging is intact and all the parts are unbroken, otherwise stop the installation and contact your retailer. The manufacturer is not responsible for damages caused by material handling or product installation.

Before installing the appliance read all these instructions carefully.

**WARNING:**

This product is made of ceramic, for that reason it requires very careful handling and installation by at least 2 people.

Start by removing the product from the packaging and lay it on a suitable surface such as a soft material such as sponge or fabric to protect the surface of the hood.

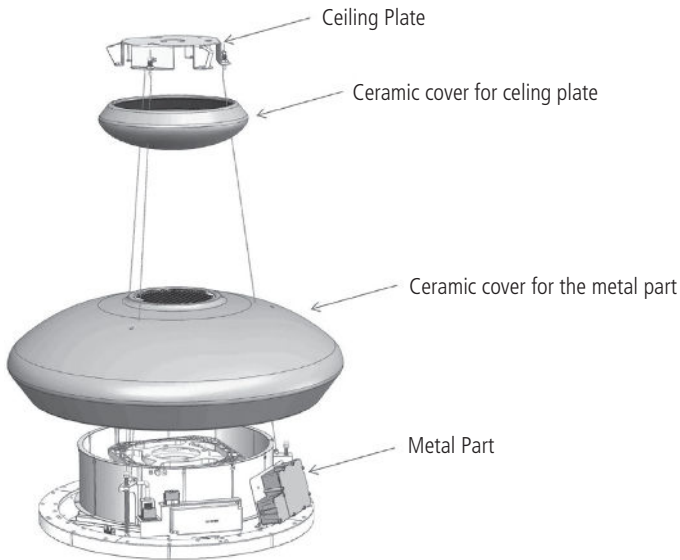

- › Using the supplied drilling template, mark and drill holes according to the four holes indicated by the template. The centre of the drilling template should correspond to the centre of the hob.
- › Insert the 3 screws into the holes/raw plugs in the same position as the holes in the ceiling fixing plate (Fig.1A). Leave the hole for the final fixing screw (Fig.2B) empty as this will be fitted later on. Ensure the heads of the 3 screws are protruding slightly to allow the fixing plate to twist into the final fixed position.

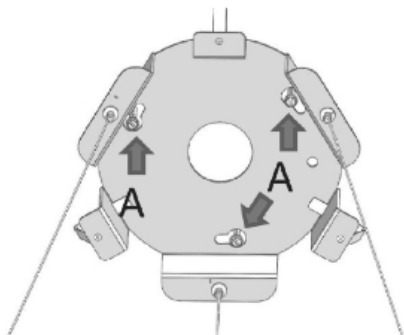

FIG.1

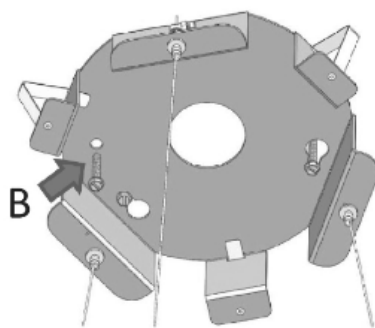

FIG.2

- › Place the ceramic cover over the extraction element and insert the steel cables into the three holes in the ceramic (Fig.3).
- › Put the power cable through the air outlet grill (Fig.4). The ceramic cover must perfectly cover the metal part. Take care when placing it into position.

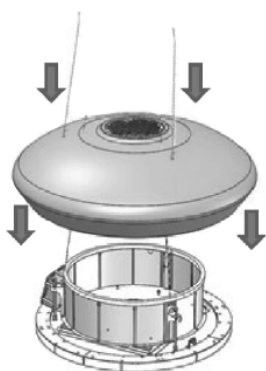

FIG.3

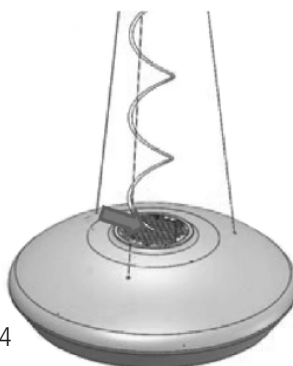

FIG.4

- › Place the ceramic cover for the ceiling plate over the hood and put the steel cables through the three holes in the ceramic body, the power cable should be put through the central hole of the ceramic (Fig.5).
- › Remove the metal plate from the packaging and then put the steel cables through the appropriate supports (Fig.6).

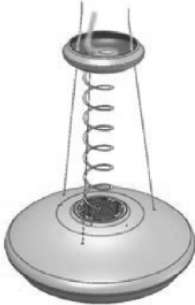

FIG.5

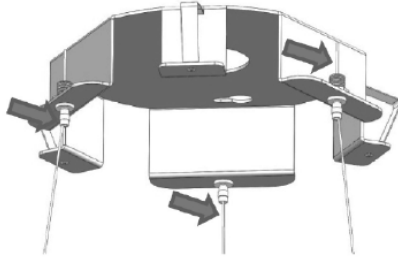

FIG.6

- › Adjust the height of the product, moving the steel cables up and down inside the support.  
It is necessary to unscrew and push the support in order to allow the movement of the cable (Fig.7).
- › Check that the remaining length of steel cables from the supports are the same, in order to ensure that it will be installed perfectly parallel to the ceiling and fully level. Tighten the appropriate support by screwing it (Fig.8) and fixing the steel cables.



FIG.7



FIG.8

- › Add the clips as a further safety precaution to lock the cables in position (Fig.9).

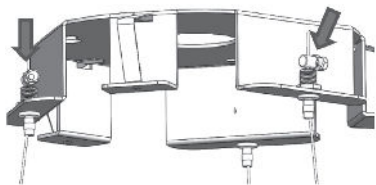

FIG.9

- › Put the hood near the ceiling and hook the plate to the screws previously installed (Fig.1A page 8).
- › Tighten the three screws fixing the plate to the ceiling, then lock the hood definitively by adding the security screw (Fig.2B page 8).

Connect the appliance to the electric grid.

**NOTE:**

The phase and neutral are not labelled due to alternating current. These wires can be connected in either position.

- › Lift up the ceramic cover until you reach the ceiling (Fig.10), make sure that the springs have hooked the ceramic cover.
- › Install the grease filter making sure to first install the hooks for the security steel cable (Fig.11).

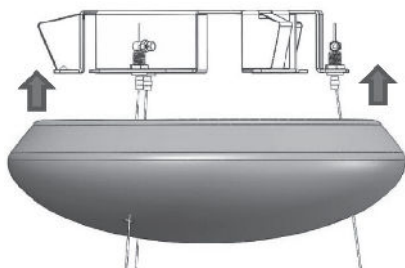

FIG.10

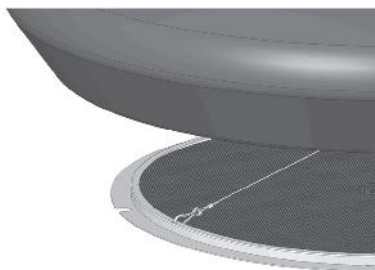

FIG.11

- › The grease filter must be positioned by orienting the dedicated opening near the speed indicator (Fig.12). In case the ceramic cover of the body is not perfectly flat or parallel to the body, it is possible to make an adjustment after installation.
- › Remove the grease filter. Using a Phillips screwdriver, (Fig.13A) tighten or loosen the three screws in order to raise or lower the ceramic body on a specific side (Fig.14). After the adjustment insert the rubber tips and the grease filter again.



FIG.12

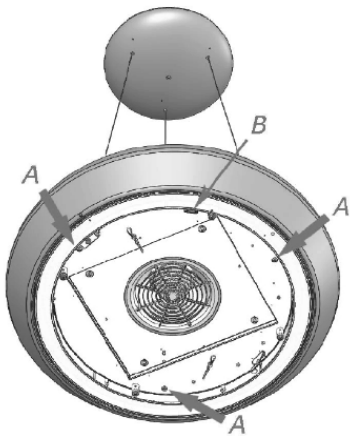

FIG.13

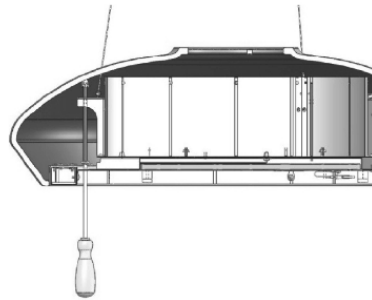

FIG.14

The cooker hood should be placed at a minimum distance of 65cm above the hob. It is the manufacturer of the hob who determines the clearance required and the clearance quoted by the hob manufacturer must be followed. In the absence of any instructions supplied with a gas hob the minimum distance between the hob and the hood must be at least 760mm.

## REMOTE CONTROL

---

When using for the first time, press and hold the light button for 5 seconds.

Remote control used for the remote operation of Caple island hoods:

### TECHNICAL DATA

Alkaline battery powered:	12V mod. 27A
Operating frequency:	433.92 Mhz
Combinations:	32.768
Max. consumption:	25 mA
Operating temperature:	-20 ÷ + 55 °C
Dimensions:	120 x 45 x 15 mm

### OPERATION

The remote is equipped with 5 buttons for cooker hood management, as specified below:



Light ON/OFF command.



Motor ON (speed level 1) / OFF command.



Reduce speed.



Increase speed.



10-minute timer.

The set extraction speed is indicated by the LED in the extraction perimeter channel.

Each colour generated by the LED, corresponds to a specific speed, as shown below:

- › First speed WHITE
- › Second speed BLUE
- › Third speed DARK BLUE
- › Fourth speed RED

## INITIAL OPERATING CONDITION

The manufacturer supplies the radio control unit ready to be used with preset codes.

## STANDARD CONFIGURATION:

Standard configuration requires all cooker hood remote controls to be provided with the same transmission code. In the event two cooker hoods radio control system are installed in the same room or nearby, each system may affect the operation of the another. Therefore, the code of one radio control system must be changed.

## GENERATING A NEW TRANSMISSION CODE:

The radio control system is provided with preset codes. Should new codes be required, proceed as follows: Press simultaneously buttons:



for two seconds. When LED's light on, press buttons:



(within 5 seconds). LED's flashing 3 times indicate the procedure is completed.

## WARNING:

This operation permanently deletes the preset codes.

## LEARNING THE NEW TRANSMISSION CODE:

Once the transmission code is changed in the remote control unit, the electronic central unit of the cooker hood must be made to set the new code in the following way:

Press the main power-off button on the hood and then restore power to the electronic control unit. Within the next 15 seconds, press the Light Button to synchronise the central unit with the code.

## RESET OF THE FACTORY CONFIGURATION:

To restore the Factory configuration, follow the procedure described below: simultaneously press buttons



for 2 seconds. When LED's light on, press buttons

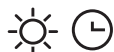

(within 5 seconds). LED's flashing 6 times indicate the procedure is completed.

### WARNING:

This operation permanently deletes the preset codes.

## EMERGENCY BUTTON:

In the event that the remote control does not work, use the emergency button to switch the appliance off.

After any necessary repairs have been performed, reset the emergency button.

### WARNING:

The battery should be replaced every year to guarantee the optimal range of the transmitter. To replace the battery, take the plastic lid off, remove the battery and replace it with a new one, observing the correct battery polarities. Used batteries should be discarded in special collection bins.

### WARNING:

Any adjustments or modifications which have not been expressly approved by the holder of the legal conformity certificate may invalidate the user's rights relating to the operation of the device.

The products are endowed with an electronic device which automatically switches the product off after 4 hours working from the last operation.



## TIMING

---

- › This product is equipped with intelligent electronics which include a timer device for speed controls when the air capacity exceeds 650m<sup>3</sup>/h. Internal motor models, with maximum air capacity higher than 650m<sup>3</sup>/h, are equipped with a timer device that automatically switches the speed from 4th to 3rd speed, after 5 minutes operation.
- › External motor models are equipped with remote motors that, as for internal motor versions, include a timer device that switches down the speed when it exceeds 650 m<sup>3</sup>/h. (See External Motors Instructions). Remote motors, whose air capacity exceeds 650m<sup>3</sup>/h at both 4th and 3rd speed, will have the following by default timer control functions: The speed is automatically switched from 4th to 2nd speed, after 6 minutes operation.
- › If the appliance is working at 3rd speed, it is automatically switched to 2nd speed, after 7 minutes operation. Operation speeds can also be changed during operation. The energy consumption of the appliance in standby mode is lower than 0.5W.

## CLEANING AND MAINTENANCE

- › An accurate maintenance guarantees good functioning and long lasting performance. Particular care must be made when handling the grease filter. The grease filter is fixed through magnets, therefore it is sufficient to insert a hand tool or the tip of a knife in the dedicated opening and push upwards in order to pull the filter out of its place (Fig.15). In order to remove the filter from the hood, unhook the two security cables, opening their snap-hooks. The active charcoal filter has to be removed after the extraction of the grease filter by pushing the specific handle (Fig.16).
- › The active charcoal filter can be washed and re-used for up to a maximum 3 years. We recommend that these are replaced during this period. To purchase replacement charcoal filters please visit [www.caple.co.uk](http://www.caple.co.uk).

### NOTE:

To clean the charcoal filters, wash by hand with warm water or in the dishwasher, and then bake in the oven at 90 degrees for 1 hour.

- › To clean the appliance itself, tepid water and neutral detergent are recommended, while abrasive products should be avoided. The power cord must be replaced only by a qualified person. The LED lamps must be replaced only by a qualified person.

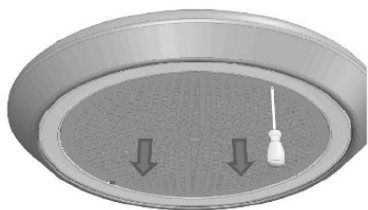

FIG.15

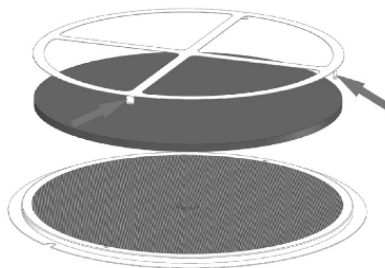
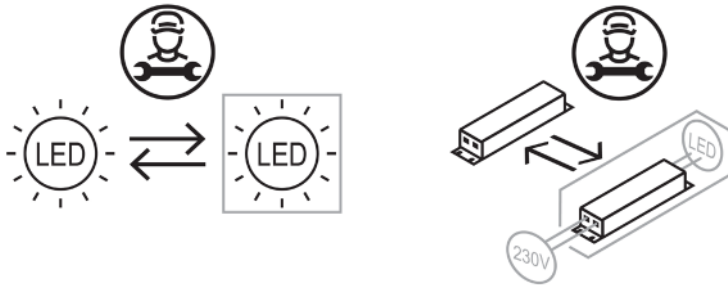



FIG.16

## REPLACING LED LIGHTING

### LIGHT SOURCE ENERGY CLASS

This product contains a light source of energy efficiency class D.



 The LED light must be replaced by an authorised engineer or similar only. For more information, please contact Caple service - 0117 938 7420 or [service@caple.co.uk](mailto:service@caple.co.uk)

 Unplug the unit from the power supply before starting the process.

1. Remove the grease filter. As the filter is fixed through magnets, apply a hand tool to the dedicated opening and push upwards in order to pull the filter out of its place. Then unhook the two security cables.

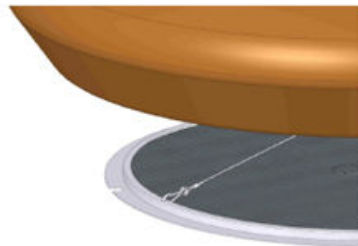
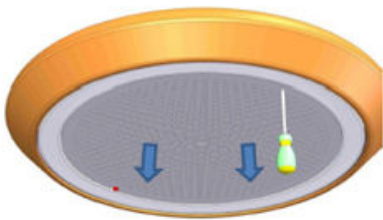

2. Remove the screws shown in the picture, then, the round LED light structure can be removed from the hood.

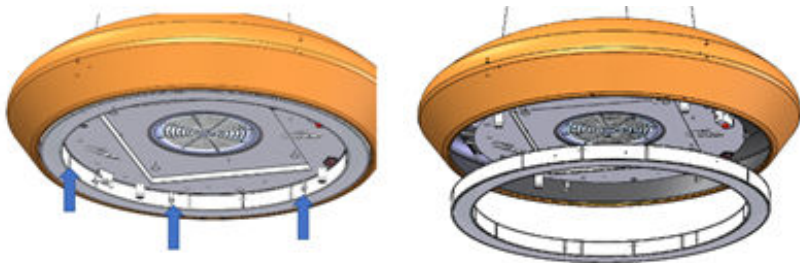

3. Carefully place the round LED light structure on a suitable work surface. Remove the upper part of the LED light structure by removing the screws.

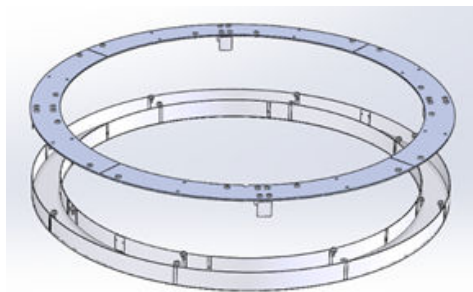

4. Carefully remove the LED light bar.

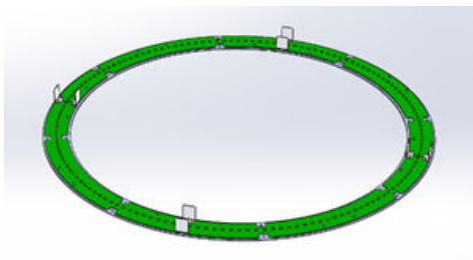

5. Disconnect the connector and change the LED light.
6. Implement the steps in reverse order.
7. After waiting 5 minutes, plug in the unit.

## AFTER SALES SERVICE

---

Any maintenance operation on your appliance should be carried out by:

- › Either your retailer;
- › Or another Caple approved engineer or similar qualified person.

If a problem still persists and further assistance is required, please contact our Caple after sales team on:

**T - 0117 938 7420**

**E - [service@caple.co.uk](mailto:service@caple.co.uk)**



Caple Service  
Fourth Way  
Avonmouth  
Bristol  
BS11 8DW

T: 0117 938 1900  
E: [service@caple.co.uk](mailto:service@caple.co.uk)  
[www.caple.co.uk](http://www.caple.co.uk)