

DIMENSIONS

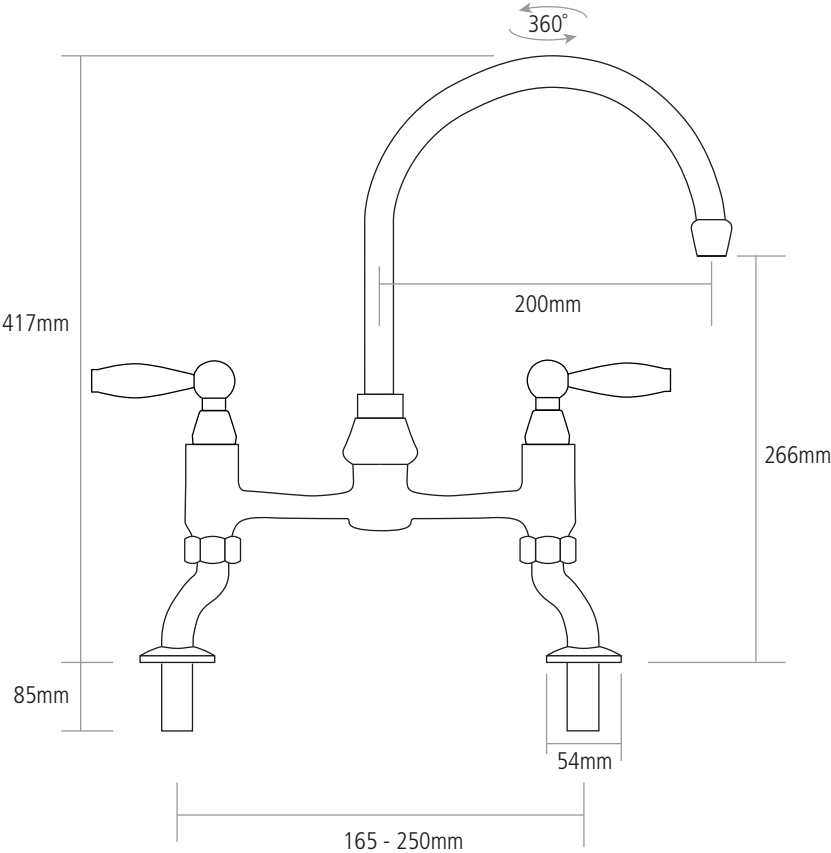

Worktop cut-out 26mm required