

Dimensions

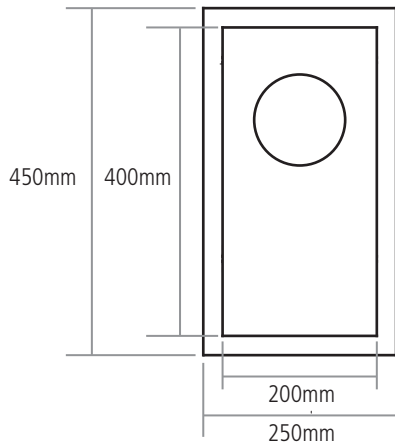

Inset cutout size 229 x 429mm

Undermount cutout size 200 x 400mm*

**Refer to template and use actual sink for the optimum undermount cutout*