

DIMENSIONS

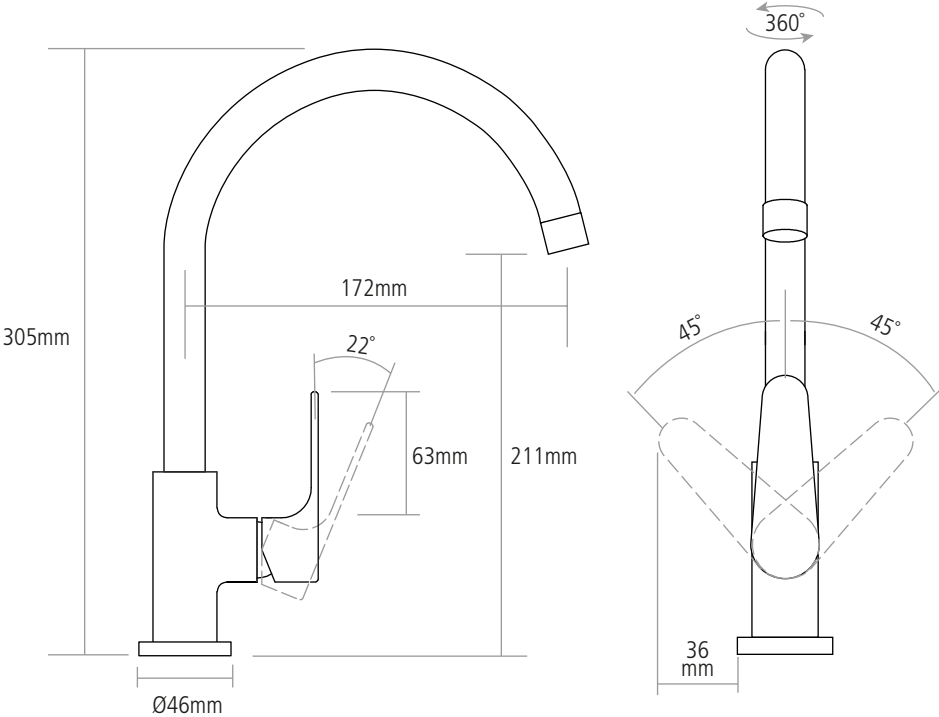

Worktop cut-out 22mm required