

DIMENSIONS

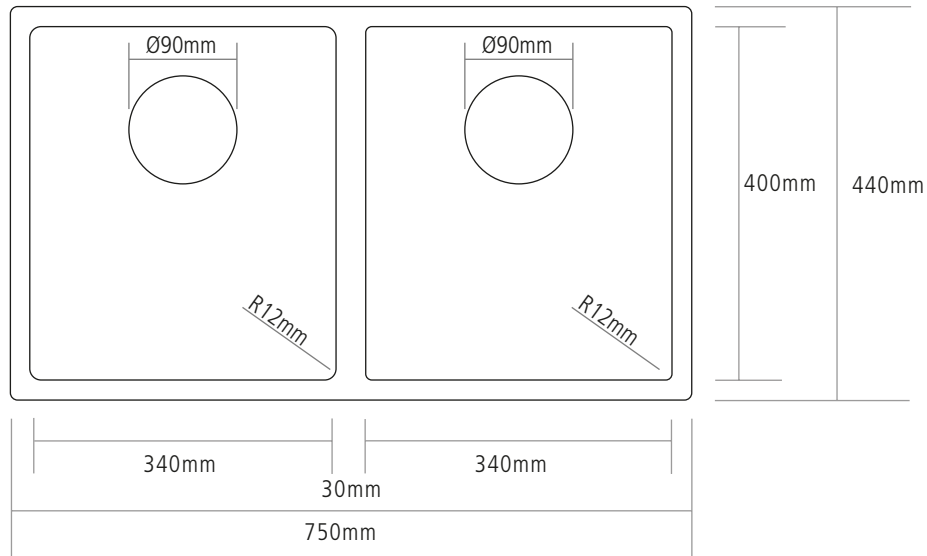

BOWL DEPTH: 200MM

MIN. BASE UNIT: 800MM

INSET CUT-OUT SIZE: 734 X 424MM

NOTE: For cut-out shape go to www.caple.co.uk for template