

Dimensions

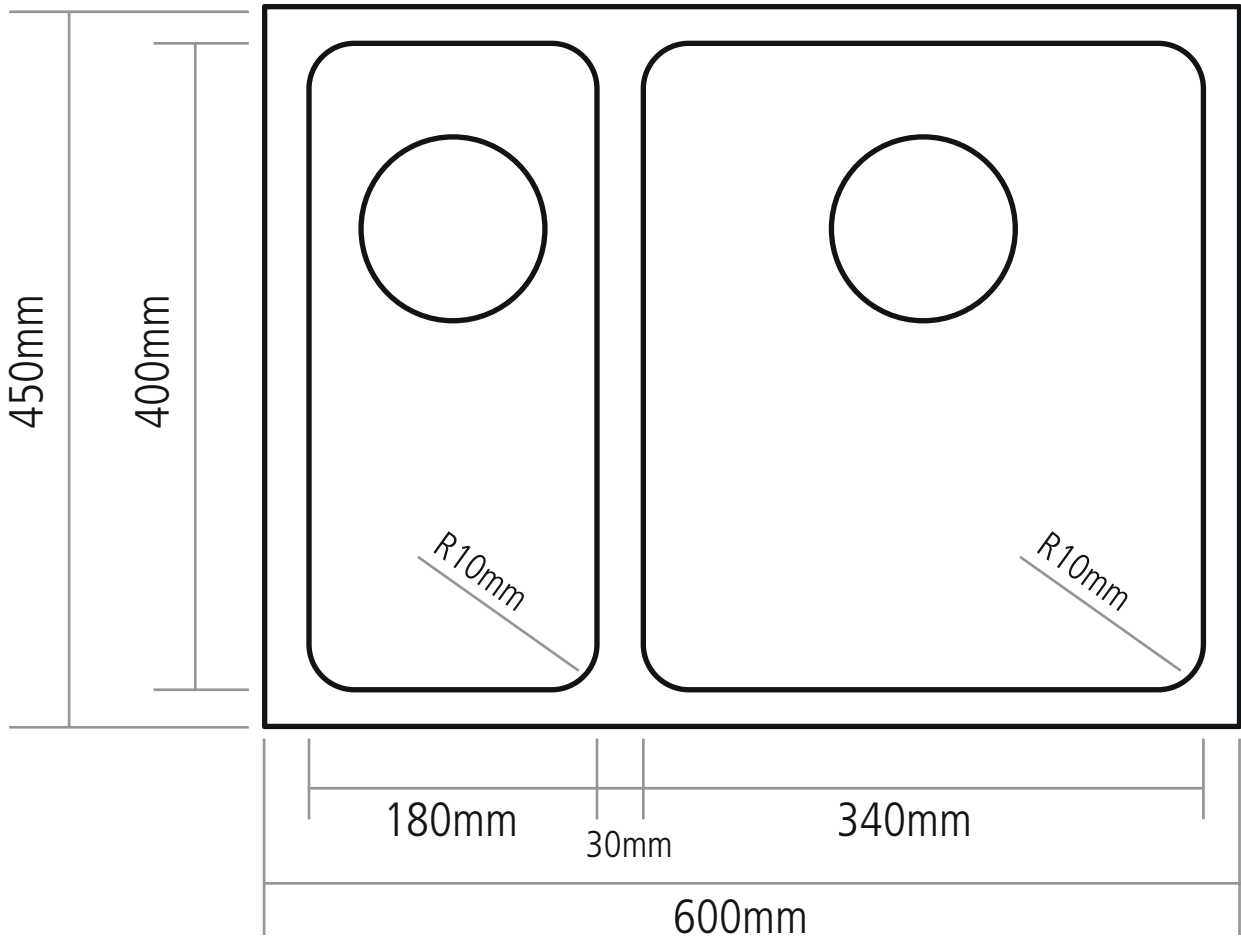

Main Bowl depth 200mm

Small Bowl depth 140mm

Min. base unit 600mm

Use template for cut-out shape
see www.cable.co.uk for template

Mode *inset installation* guide

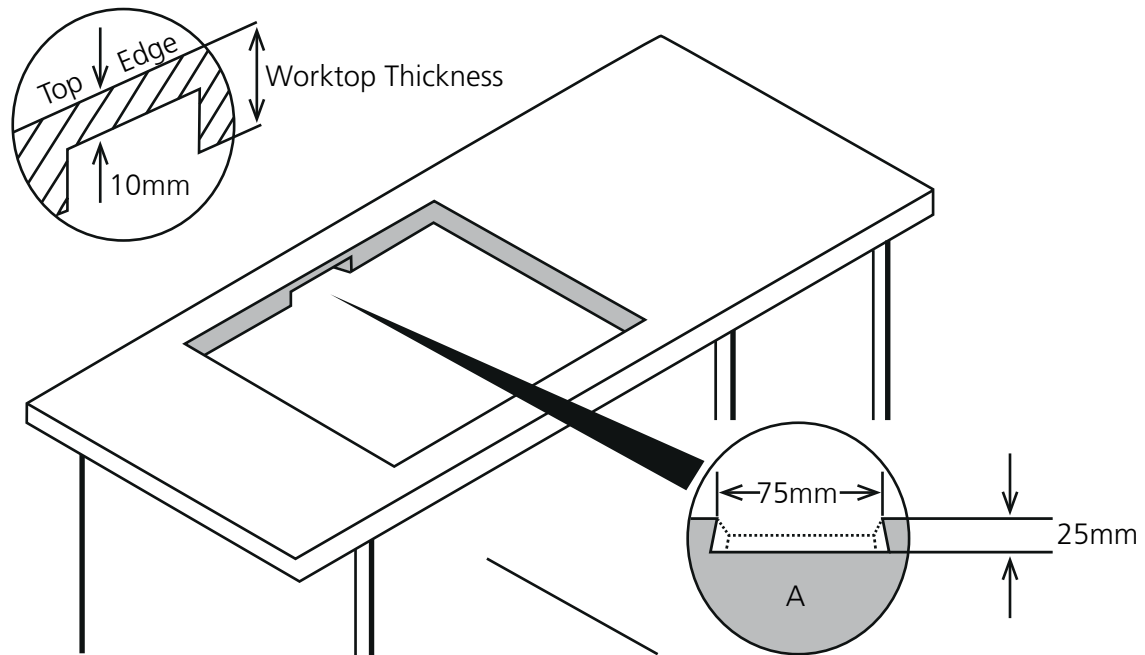

PLEASE NOTE.

When **INSET FITTING** the **MODE** sinks a recess/notch will need to be made in the underside of the worktop to enable the overflow to be fitted to the sink. View A shows the worktop from the underside.

Check the required position of the recess/notch by offering the sink (with overflow fitted) into the cut-out. Then mark your worktop in the required position. (For guidance the recess/notch should be approximately 75mm wide and 25mm deep, and 10mm from the top edge of the worktop.

When cutting the recess/notch ensure there is enough clearance for the complete overflow body.
