



Zalto Island Extractor Instruction Manual

ZAL48CO, ZAL48SL, ZAL48BK



Contact Caple on 0117 938 7420 for spare parts or www.caple.co.uk

CONTENTS

Introduction	3
Safety Instructions and Warnings	4
Environmental Protection	7
Installation	8
Remote Control	11
Timing	14
Care and Maintenance	15
Caple Contact Details	16

INTRODUCTION

Thank you for choosing this Caple island extractor.

To ensure that you get the best results from your new extractor, we strongly suggest that you read this instruction manual thoroughly before use. If treated with care, your Caple product should give you years of trouble-free use.

To register ownership, please ensure you complete and return the guarantee card supplied with the appliance or visit www.caple.co.uk and register here.

This instruction manual is designed to provide you with all the required information related to the installation, use and maintenance of the appliance.

This extractor is designed to extract unpleasant odours and cooking vapours from the kitchen. In order to operate the unit correctly and safely, please read this instruction manual carefully before installation and use.

Please read this manual carefully before using your appliance. It contains important safety advice; it explains how to use and look after your appliance so that it will provide you with many years of reliable service.

Please keep this manual in a safe place and pass it on to new owners for their information and safety.

SAFETY INSTRUCTIONS AND WARNINGS:

- The cooker surface and the inferior part of the cooker hood must be at a minimum distance of 65 cm.
- The appliance is not intended for use by young children or infirm persons without supervision. Young children should be supervised to ensure they do not play with the appliance.
- When performing the electrical connections on the appliance, please make sure that the current-tap is provided with earth connection and that voltage values correspond to those indicated on the rating label placed inside the appliance itself.
- Please disconnect the appliance from power mains, before carrying out any cleaning or maintenance operation. If the appliance is not equipped with a non-separable flexible cable and plug, or with another device ensuring omnipolar disconnection from the mains, with an opening distance between the contacts of at least 3 mm, then such disconnecting devices must be provided in the fixed installation.
- If the appliance is equipped with a powercord and a plug, it shall be placed in such a way that the plug can be reached easily.

- The use of materials which can burst into flames should be avoided in close proximity of the appliance. When frying, please pay particular attention to fire risk due to oil and grease. Being highly inflammable, fried oil is especially dangerous. Do not use uncovered electric grills. In order to avoid possible fire risk, all instructions for grease filter cleaning and for removing eventual grease deposits should be strictly followed.
- Two persons are needed for the installation of this product.
- This appliance complies with all relevant local and national safety requirements. Inappropriate use can, however, lead to personal injury and damage to property.
- The cooker hood is not intended for outdoor use.
- It must only be used as a domestic appliance to extract vapours and remove odours from cooking. Any other usage is not supported by the manufacturer and could be dangerous.
- Where a recirculation cooker hood is fitted above a gas hob, please ensure that there is an adequate supply of fresh air into the room in which it is installed. Please seek the advice of a qualified gas fitter (e.g. GasSafe in the UK) if necessary.
- Children under 8 years of age must be kept away from the cooker hood unless they are constantly supervised.

- Children 8 years and older may only use the cooker hood unsupervised if they have been shown how to use it safely and recognise and understand the consequences of incorrect operation.
- The electrical safety of this appliance can only be guaranteed when correctly earthed. It is essential that this standard safety requirement is met. If in any doubt please have the electrical installation tested by a qualified electrician.
- Do not connect the appliance to the mains electricity supply by a multi-socket unit or an extension lead. These are a fire hazard and do not guarantee the required safety of the appliance.
- The cooker hood can get very hot during cooking due to heat rising from the hob.
- Do not touch the housing or the grease filters until the cooker hood has cooled down.



ENVIRONMENTAL PROTECTION

Waste electrical products should not be disposed of with household waste. Please recycle where facilities exist. Check with your Local Authority or retailer for recycling advice. This appliance is marked according to the European directive on Waste Electrical and Electronic Equipment (WEEE).

By ensuring this product is disposed of correctly, you will help prevent potential negative consequences for the environment and human health, which could otherwise be caused by inappropriate waste handling of this product. The symbol on the product indicates that this product may not be treated as household waste. Instead it shall be handed over to the applicable collection point for the recycling of electrical and electronic equipment. Disposal must be carried out in accordance with local environmental regulations for waste disposal.

For more detailed information about treatment, recovery and recycling of this product, please contact your local council, your household waste disposal service or the retailer where you purchased the product.

WARRANTY

Your new appliance is covered by warranty. The warranty card is enclosed - if it is missing, you must provide the following information to your retailer in order to receive a replacement: date of purchase, model and serial number. Registration can also be completed online by visiting www.caple.co.uk.

Ensure you keep your warranty card safe, you may need to show it to Caple Service together with proof of purchase. If you fail to show your warranty card you will incur all repair charges.

Spare parts are only available from Caple Service and spare parts authorised centres.

CE DECLARATIONS OF CONFORMITY



This appliance has been manufactured to the strictest standards and complies with all applicable legislation, Low Voltage Directive (LVD) and Electromagnetic Compatibility (EMC).

UKCA DECLARATIONS OF CONFORMITY



This appliance has been manufactured to the strictest standards and complies with all applicable legislation.

TECHNICAL FICHE

This appliance conforms to all current and applicable energy regulations. To view the Technical Fiche that supports the energy labelling data, please visit the product page on our website www.caple.co.uk.

INSTALLATION

This appliance can be used in recirculation mode only. In recirculation mode the air and fumes conveyed by the appliance are cleaned by both a grease filter and an active charcoal filter, and then released back into the room.

Prior to installation, make sure that the packaging is intact and all the parts are unbroken, otherwise stop the installation and contact your retailer. The manufacturer is not responsible for damages caused by material handling or product installation.

Before installing the appliance read all these instructions carefully.

Start by removing the product from the packaging and lay it on a suitable surface such as a soft material such as sponge or fabric to protect the surface of the hood.



- › Take the mounting plate out of the packaging (Fig.1); to install the hood, position it in the desired place of the ceiling, making sure the centre of the plate is aligned with the centre of the hob.
- › Check that the ceiling structure is suitable to bear the weight of the appliance. Mark the holes to be drilled at the smaller openings of the plate (Fig.2). Drill the holes using an 8mm diameter twist drill.

Fig 1.

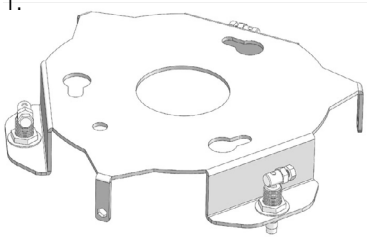
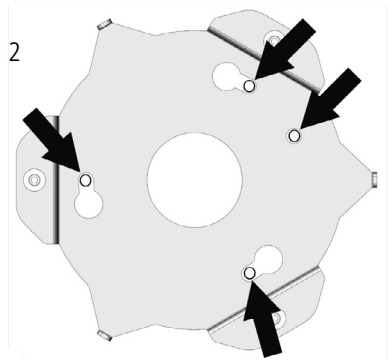

Fig 2



- › Fix the plate to the ceiling, by using the plastic dowels and the screws supplied with the appliance.
- › Take the ceiling plate cover out of the packaging and then introduce the power cord and the three steel wires into the holes (Fig.3). Place the appliance close to the ceiling plate, and then insert the steel wires into the specific supports (Fig.4).

Fig 3

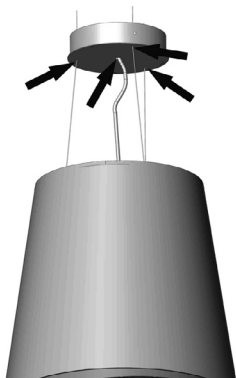
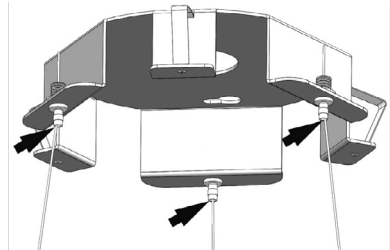

Fig 4



- › Adjust the height of the product, moving the steel cables up and down inside the support. It is necessary to unscrew and push the support in order to allow the movement of the cable (Fig.5).
- › Check that the remaining length of steel cables from the supports are the same, in order to ensure that it will be installed perfectly parallel to the ceiling and fully level. Tighten the appropriate support by screwing it (Fig.6) and fixing the steel cables.

Fig 5

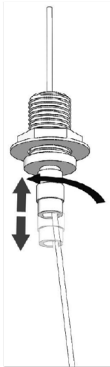
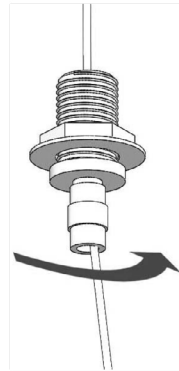

Fig 6



- › Add the clips as a further safety precaution to lock the cables in position (Fig.7).
- › Perform the electrical connection.
- › Place the ceiling plate cover in such a way as to hide the plate previously mounted, then secure it by using the three screws provided (Fig.8).

Fig 7

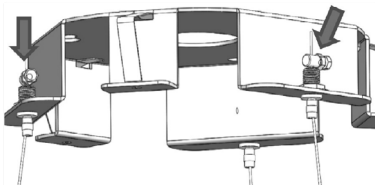
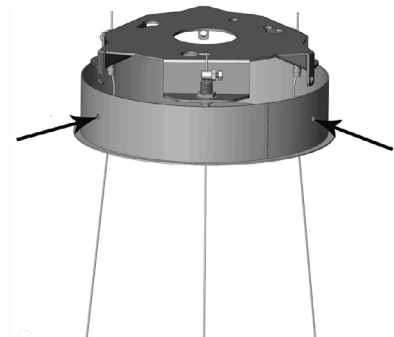

Fig 8



REMOTE CONTROL

When using for the first time, press and hold the light button for 5 seconds.

Remote control used for the remote operation of Caple island hoods:

ALKALINE BATTERY POWERED	12 V mod. 27 A
OPERATING FREQUENCY	433.92 Mhz
COMBINATIONS	32.768
MAX. CONSUMPTION	25 mA
OPERATING TEMPERATURE	-20 ÷ + 55 °C
DIMENSIONS	120 x 45 x 15 mm

OPERATION

The remote is equipped with 5 buttons for cooker hood management, as specified below:



Light ON/OFF command.



Motor ON (speed level 1) / OFF command.



Reduce speed.



Increase speed.



10-minute timer.

INITIAL OPERATING CONDITION

The manufacturer supplies the remote control ready to be used with codes pre-set in the Factory.



STANDARD CONFIGURATION:

Standard configuration requires all cooker hood remote controls to be provided with the same transmission code. In the event two cooker hood remote control systems are installed in the same room or nearby, each system may affect the operation of the another. Therefore, the code of one radio control system must be changed.

GENERATING A NEW TRANSMISSION CODE:

The remote control system is provided with pre-set codes. Should new codes be required, proceed as follows: Press simultaneously buttons:



for two seconds. When LEDs light on, press buttons:



(within 5 seconds). LEDs flashing 3 times indicate the procedure is completed.

WARNING:

This operation permanently deletes the pre-set codes.

LEARNING THE NEW TRANSMISSION CODE:

Once the transmission code is changed in the remote control unit, the electronic central unit of the cooker hood must be made to set the new code in the following way:

Press the main power-off button of the hood and then restore power to the electronic control unit. Within the next 15 seconds, press the Light Button  to synchronise the central unit with the code.

RESET OF THE FACTORY CONFIGURATION:

To restore the Factory configuration, follow the procedure described below: press simultaneously buttons:



for 2 seconds. When LEDs light on, press buttons

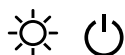

(within 5 seconds). LEDs flashing 6 times indicate the procedure is completed.

WARNING:

This operation permanently deletes the pre-set codes.

EMERGENCY BUTTON:

In the event that the remote control does not work, use the emergency button to switch the appliance off.

After any necessary repairs have been performed, reset the emergency button.

WARNING:

The battery should be replaced every year to guarantee the optimal range of the transmitter. To replace the battery, take the plastic lid off, remove the battery and replace it with a new one, observing the correct battery polarities. Used batteries should be discarded in special collection bins.

WARNING:

Any adjustments or modifications which have not been expressly approved by the holder of the legal conformity certificate may invalidate the user's rights relating to the operation of the device.

The products are endowed with an electronic device which allows the automatic switching off after 4 hours working from the last operation.

TIMING

- › This product is equipped with intelligent electronics which include a timer device for speed controls when the air capacity exceeds 650m³/h. Internal motor models, with maximum air capacity higher than 650m³/h, are equipped with a timer device that automatically switches the speed from 4th to 3rd speed, after 6 minutes operation.
- › External motor models are equipped with remote motors that, as for internal motor versions, include a timer device that switches down the speed when it exceeds 650 m³/h.(See External Motors Instructions). Remote motors, whose air capacity exceeds 650m³/h at both 4th and 3rd speed, will have the following by default timer control functions: The speed is automatically switched from 4th to 2nd speed, after 6 minutes operation.
- › If the appliance is working at 3rd speed, it is automatically switched to 2nd speed, after 7 minutes operation. Operation speeds can also be changed during operation. The energy consumption of the appliance in standby mode is lower than 0.5W.

CARE AND MAINTENANCE

- › An accurate maintenance guarantees good functioning and long-lasting performance.
- › Particular care must be made when handling the grease filter. Rotate the lower panel of the appliance by pulling the side knob (Fig.10). Remove the grease filter by acting on the side handle. After cleaning or replacement operations refit the grease filter and close the lower panel previously opened.
- › The active charcoal filter used in these hoods can be washed and re-used for up to a maximum 3 years. We recommend that these are replaced during this period.
- › To purchase replacement charcoal filters please visit www.caple.co.uk
- › To wash the charcoal filters, wash by hand with warm water or in the dishwasher, and then bake in the oven at 90 degrees for 1 hour.
- › To clean the appliance itself tepid water and neutral detergent are recommended, while abrasive products should be avoided.
- › The power cord must be replaced only by qualified person.
- › To replace the fluorescent circular lamp rotate the lower panel of the appliance by pulling the side knob (Fig. 9-10). Remove the screws found on the panel and open it; replace the fluorescent lamp and then refit the panel.

Fig 9



Fig 10

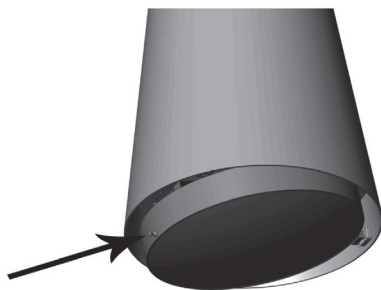



Caple Service

Fourth Way

Avonmouth

Bristol

BS11 8DW

T: 0117 938 1900

E: service@caple.co.uk

www.caple.co.uk