

Instruction manual for built-in microwave

Model code: CM2400



Congratulations on purchasing your Caple Microwave.

Please read this instruction manual carefully before using your new microwave and keep for future reference.

If you follow the instructions, your product will provide you with many years of service.

Caple

PRECAUTIONS TO AVOID POSSIBLE EXPOSURE TO EXCESSIVE MICROWAVE ENERGY

- (a) Do not attempt to operate this oven with the door open, this can result in harmful exposure to microwave energy. It is important not to break or tamper with the safety interlocks.
- (b) Do not place any object between the oven front face and the door or allow food or cleaner residue to accumulate on sealing surfaces.
- (c) **WARNING:** If the door or door seals are damaged, the oven must not be operated until it has been repaired by a competent person. Please contact Caple Service on 0844 800 3830 or email service@caple.co.uk.

ADDENDUM

If the apparatus is not maintained in a good state of cleanliness, its surface could be degraded and affect the lifespan of the apparatus and lead to a dangerous situation.

Specifications

Model:	CM2400
Rated Voltage:	230V~50Hz
Rated Input Power (Microwave):	1450W
Rated Output Power (Microwave):	900W
Rated Input Power (Grill):	1000W
Oven Capacity:	25L
Turntable Diameter:	Ø315mm
External Dimensions (WxDxH):	595 x 400 x 388 mm
Net Weight:	Approx. 19 kg

IMPORTANT SAFETY INSTRUCTIONS

WARNING To reduce the risk of fire, electric shock, injury to persons or exposure to excessive microwave oven energy when using your appliance follow basic precautions, including the following:

1. Warning: Liquids and other foods must not be heated in sealed containers as they are liable to explode.
2. Warning: It is hazardous for anyone other than a competent person to carry out any service or repair operation that involves the removal of a cover which gives protection against exposure to microwave energy.
3. This appliance can be used by children aged from 8 years and above and persons with reduced physical, sensory or mental capabilities or lack of experience and knowledge if they have been given supervision or instruction concerning use of the appliance in a safe way and understand the hazards involved. Children must not play with the appliance. Cleaning and user maintenance shall not be made by children unless they are older than 8 and supervised.
4. Keep the appliance and its cord out of reach of children less than 8 years.
5. Only use utensils suitable for use in microwave ovens.
6. The oven should be cleaned regularly and any food deposits should be removed.
7. Read and follow the specific: "PRECAUTIONS TO AVOID POSSIBLE EXPOSURE TO EXCESSIVE MICROWAVE ENERGY".
8. When heating food in plastic or paper containers, keep an eye on the oven due to the possibility of ignition.
9. If smoke is emitted, switch off or unplug the appliance and keep the door closed in order to stifle any flames.

10. Do not overcook food.
11. Do not use the oven cavity for storage purposes. Do not store items, such as bread, cookies, etc. inside the oven.
12. Remove wire twists and metal handles from paper or plastic containers/bags before placing them in the oven.
13. Install or locate this oven only in accordance with the installation instructions provided.
14. Eggs in the shell and whole hard-boiled eggs should not be heated in microwave ovens since they may explode, even after microwave heating has ended.
15. This appliance is intended to be used in household and similar applications such as:
 - staff kitchen areas in shops, offices and other working environments;
 - by clients in hotels, motels and other residential type environments;
 - farm houses;
 - bed and breakfast type environments.
16. If the supply cord is damaged, it must be replaced by the manufacturer, its service agent or similarly qualified persons in order to avoid a hazard.
17. Do not store or use this appliance outdoors.
18. Do not use this oven near water, in a wet basement or near a swimming pool.
19. The temperature of accessible surfaces may be high when the appliance is operating. The surfaces are liable to get hot during use. Keep the cord away from heated surfaces, and do not cover any vents on the oven.
20. Do not let the cord hang over edge of a table or counter.
21. Failure to maintain the oven in a clean condition could lead to deterioration of the surface that could adversely affect the life of the appliance and possibly result in a hazardous situation.

22. The contents of feeding bottles and baby food jars must be well stirred or shaken and the temperature checked before consumption, in order to avoid burns.
23. Microwave heating of beverages can result in delayed eruptive boiling, therefore care must be taken when handling the container.
24. The appliance is not intended for use by persons (including children) with reduced physical, sensory or mental capabilities, or lack of experience and knowledge, unless they have been given supervision or instruction concerning use of the appliance by a person responsible for their safety.
25. Children should be supervised to ensure that they do not play with the appliance.
26. The appliances are not intended to be operated by means of an external timer or separate remote-control system.
27. Accessible parts may become hot during use. Young children should be kept away.
28. Steam cleaners must not be used.
29. During use the appliance becomes hot. Care should be taken to avoid touching heating elements inside the oven.
30. **WARNING:** The appliance and its accessible parts become hot during use. Care should be taken to avoid touching heating elements. Children less than 8 years of age shall be kept away unless continuously supervised.
31. The microwave oven must be operated with the decorative door open. (for ovens with a decorative door.)
32. Surface of a storage cabinet can get hot.

READ CAREFULLY AND KEEP FOR FUTURE REFERENCE

Grounding installation

DANGER

Electric Shock Hazard

Touching some of the internal components can cause serious personal injury or death. Do not disassemble this appliance.

WARNING

Electric Shock Hazard

Improper use of the grounding can result in electric shock. Do not plug into an outlet until appliance is properly installed and grounded.

This appliance must be grounded/earthed. In the event of an electrical short circuit, grounding reduces the risk of electric shock by providing an escape wire for the electric current. This appliance is equipped with a cord having a grounding wire with a grounding plug. The plug must be plugged into an outlet that is properly installed and grounded.

Consult a qualified electrician or serviceman if the grounding instructions are not completely understood or if doubt exists as to whether the appliance is properly grounded. If it is necessary to use an extension cord, use only a 3-wire extension cord.

1. A short power-supply cord is provided to reduce the risks resulting from becoming entangled in or tripping over a longer cord.

2. If a long cord set is used:

1)The marked electrical rating of the cord set or extension cord should be at least as great as the electrical rating of the appliance.

2)The extension cord must be a grounding-type 3-wire cord.

3)The long cord should be arranged so that it will not drape over the counter top or tabletop where it can be pulled on by children or tripped over unintentionally.

CLEANING

Be sure to unplug the appliance from the power supply.

1. Clean the cavity of the oven after using with a slightly damp cloth.

2. Clean the accessories in the usual way in soapy water.

3. The door frame and seal and neighbouring parts must be cleaned carefully with a damp cloth when they are dirty.

4. Do not use harsh abrasive cleaners or sharp metal scrapers to clean the oven door glass since they can scratch the surface, which may result in shattering of the glass.

5. Cleaning Tip: For easier cleaning of the cavity walls that the food cooked can touch:

Place half a lemon in a bowl, add 300ml (1/2 pint) water and heat on 100% microwave power for 10 minutes.

Wipe the oven clean using a soft, dry cloth.

UTENSILS

CAUTION

Personal Injury Hazard

It is hazardous for anyone other than a competent person to carry out any service or repair operation that involves the removal of a cover which gives protection against exposure to microwave energy.

See the instructions on "Materials you can use in microwave oven" There may be certain non-metallic utensils that are not safe to use for microwaving. If in doubt, you can test the utensil in question following the procedure below.

Utensil Test:

1. Fill a microwave-safe container with 1 cup of cold water (250ml) along with the utensil in question.
2. Cook on maximum power for 1 minute.
3. Carefully feel the utensil. If the empty utensil is warm, do not use it for microwave cooking.
4. Do not exceed 1 minute cooking time.

Materials you can use in microwave oven

Utensils	Remarks
Aluminum foil	Shielding only. Small smooth pieces can be used to cover thin parts of meat or poultry to prevent overcooking. Arcing can occur if foil is too close to oven walls. The foil should be at least 1 inch (2.5cm) away from oven walls.
Browning dish	Follow manufacturer's instructions. The bottom of the browning dish must be at least 3/16 inch (5mm) above the turntable. Incorrect usage may cause the turntable to break.
Dinnerware	Microwave-safe only. Follow manufacturer's instructions. Do not use cracked or chipped dishes.
Glass jars	Always remove lid. Use only to heat food until just warm. Most glass jars are not heat resistant and may break.
Glassware	Heat-resistant oven glassware only. Make sure there is no metallic trim. Do not use cracked or chipped dishes.
Oven cooking bags	Follow manufacturer's instructions. Do not close with metal tie. Make slits to allow steam to escape.
Paper plates and cups	Use for short-term cooking/warming only. Do not leave oven unattended while cooking.
Paper towels	Use to cover food for reheating and absorbing fat. Use with supervision for a short-term cooking only.
Parchment paper	Use as a cover to prevent splattering or a wrap for steaming.
Plastic	Microwave-safe only. Follow the manufacturer's instructions. Should be labelled "Microwave Safe". Some plastic containers soften, as the food inside gets hot. "Boiling bags" and tightly closed plastic bags should be slit, pierced or vented as directed by package.
Plastic wrap	Microwave-safe only. Use to cover food during cooking to retain moisture. Do not allow plastic wrap to touch food.
Thermometers	Microwave-safe only (meat and candy thermometers).
Wax paper	Use as a cover to prevent splattering and retain moisture.

Materials to be avoided in microwave oven

Utensils	Remarks
Aluminum tray	May cause arcing. Transfer food into microwave-safe dish.
Food carton with metal handle	May cause arcing. Transfer food into microwave-safe dish.
Metal or metal-trimmed utensils	Metal shields the food from microwave energy. Metal trim may cause arcing.
Metal twist ties	May cause arcing and could cause a fire in the oven.
Paper bags	May cause a fire in the oven.
Plastic foam	Plastic foam may melt or contaminate the liquid inside when exposed to high temperature.
Wood	Wood will dry out when used in the microwave oven and may split or crack.

SETTING UP YOUR OVEN

Names of oven parts and accessories

Remove the oven and all materials from the carton and oven cavity.

Your oven comes with the following accessories:

- Glass tray 1
- Turntable ring assembly 1
- Instruction Manual 1

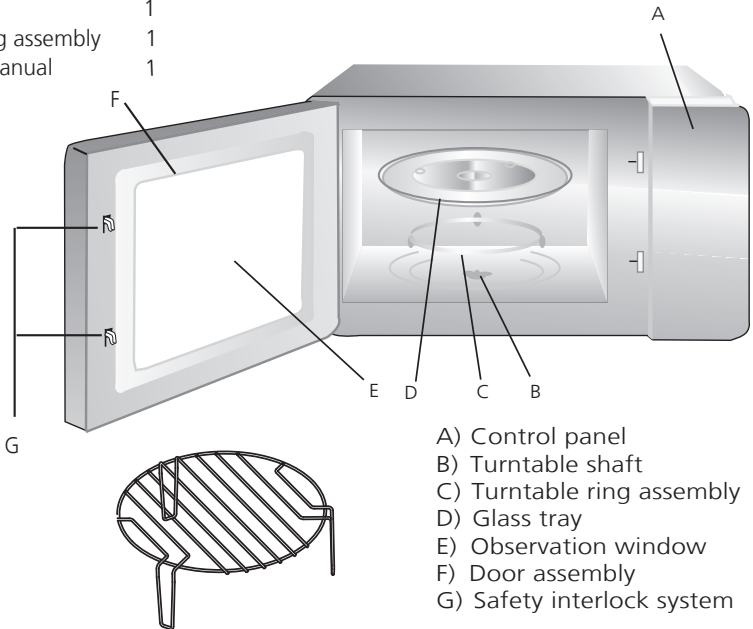

- A) Control panel
- B) Turntable shaft
- C) Turntable ring assembly
- D) Glass tray
- E) Observation window
- F) Door assembly
- G) Safety interlock system

Grill Rack(must only be used in the grill function and be placed on the glass tray)

Turntable installation

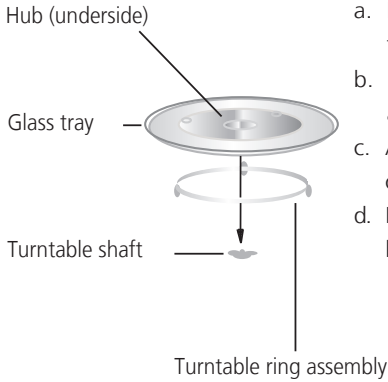

- a. Never place the glass tray upside down. The glass tray should never be restricted.
- b. Both glass tray and turntable ring assembly must always be used during cooking.
- c. All food and containers of food are always placed on the glass tray for cooking.
- d. If the glass tray or turntable ring assembly cracks or breaks, contact your nearest Caple service center.

Installation and connection

1. This appliance is only intended for domestic use.
2. This oven is intended for built-in use only. It is not intended for counter-top use or for use inside a cupboard.
3. Please observe the special installation instructions.
4. The appliance can be installed in a 60cm wide wall-mounted cupboard (at least 55cm deep and 85cm off the floor).
5. The appliance is fitted with a plug and must only be connected to a properly installed earthed socket.
6. The mains voltage must correspond to the voltage specified on the rating plate.
7. The socket must be installed and connecting cable must only be replaced by a qualified electrician. If the plug is no longer accessible following installation, an all-pole disconnecting device must be present on the installation side with a contact gap of at least 3mm.
8. Adapters, multi-way strips and extension leads must not be used. Overloading can result in a risk of fire.

The accessible surface may be hot during operation.



Installation Instructions

Please Read the Manual Carefully Before Installation

Please note

Electrical connection

The oven is fitted with a plug and must only be connected to a properly installed earthed socket. The socket must only be installed and the connecting cable must only be replaced by a qualified electrician, and in accordance with the appropriate regulations.

If the plug is no longer accessible following installation, an all-pole isolating switch must be present on the installation side with a contact gap of at least 3 mm.

The fitted cabinet must not have a back wall behind the appliance.

Minimum installation height: 85 cm.

Do not cover ventilation slots and suction holes.

Note:

Do not trap or bend the power cable.

A. Built-in furniture

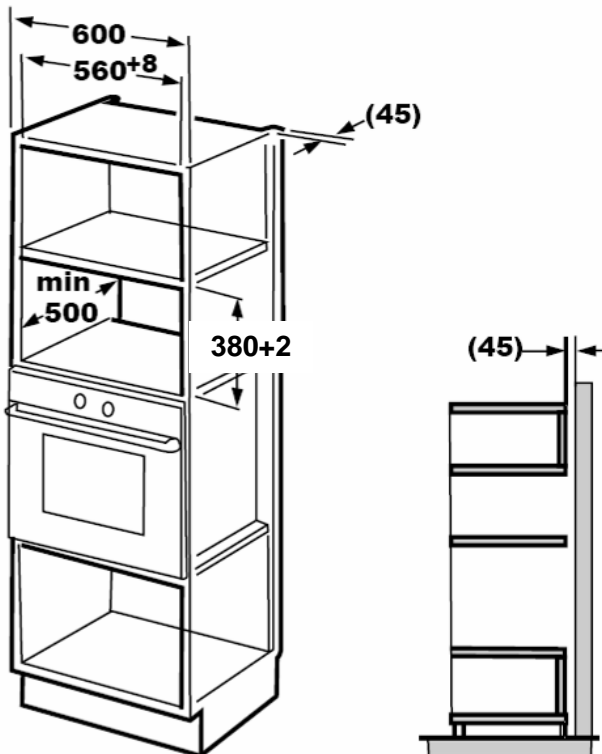

B.Prepare the cabinet

1. Read the instruction on the BOTTOM CABINET TEMPLATE, put the template on the bottom plane of cabinet.

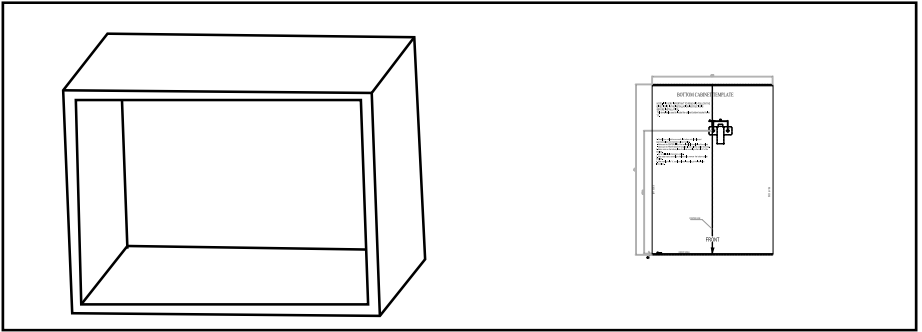

2. Make the marks on the bottom plane of cabinet according to marks "a" on the template

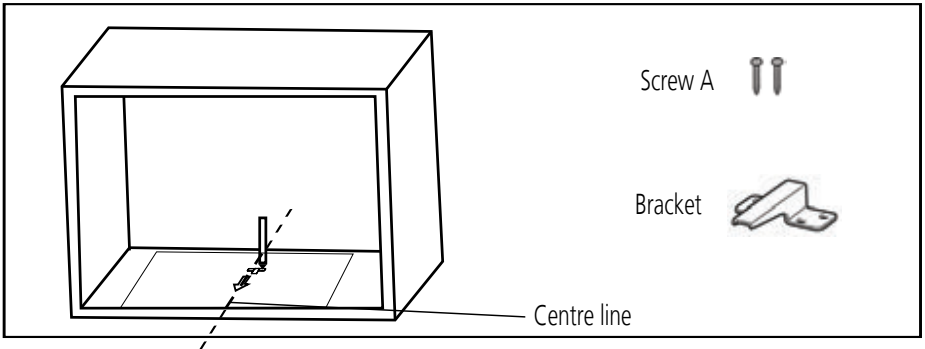

3. Remove the bottom cabinet template and fix the bracket with screw A.

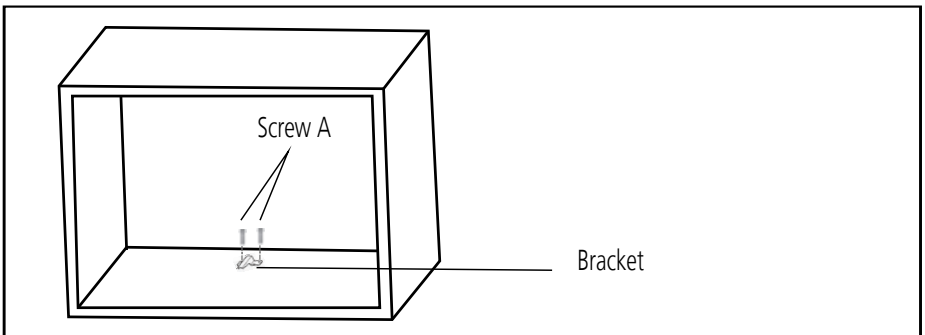

C. Install the oven

4. Install the oven to the cabinet

- Make sure the back of the oven is locked by the bracket -
- Take care not to trap or kink the power cord.

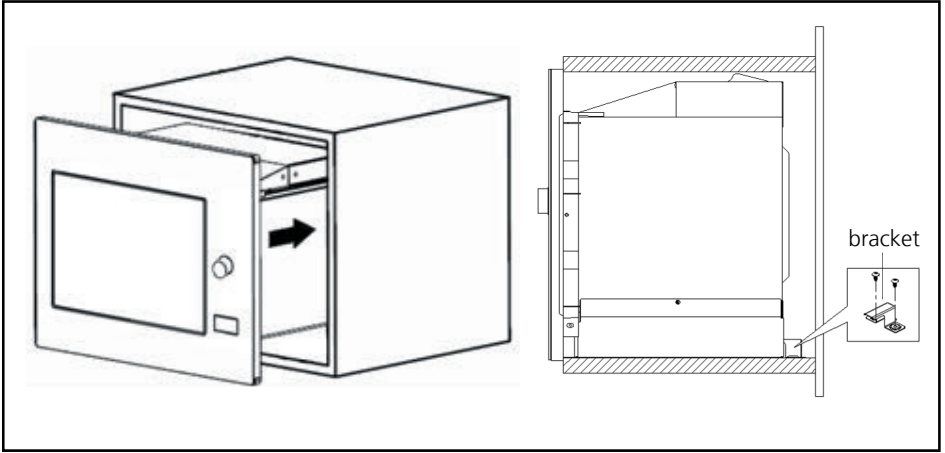

5. Open the door, fix the oven to the cabinet with Screw B, at the installation hole.

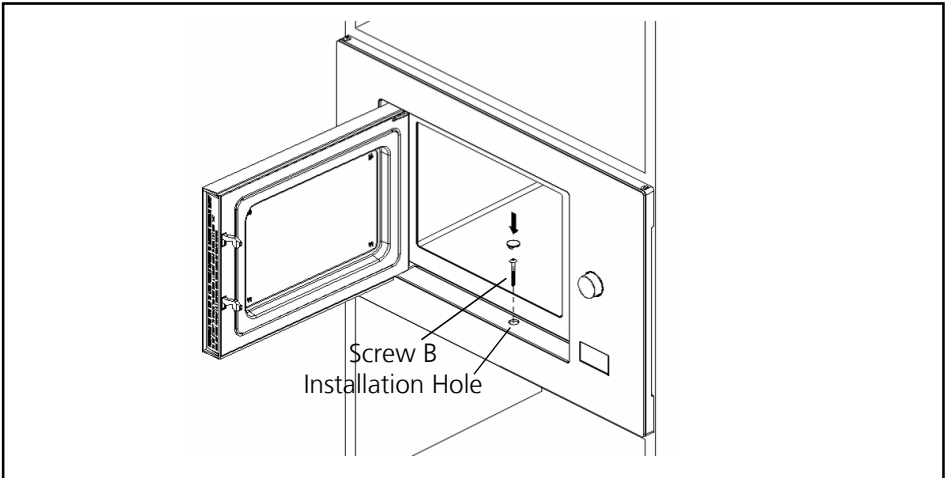

CONTROL PANEL

The below diagram shows the functions of each button and the following pages explain the operation instructions.

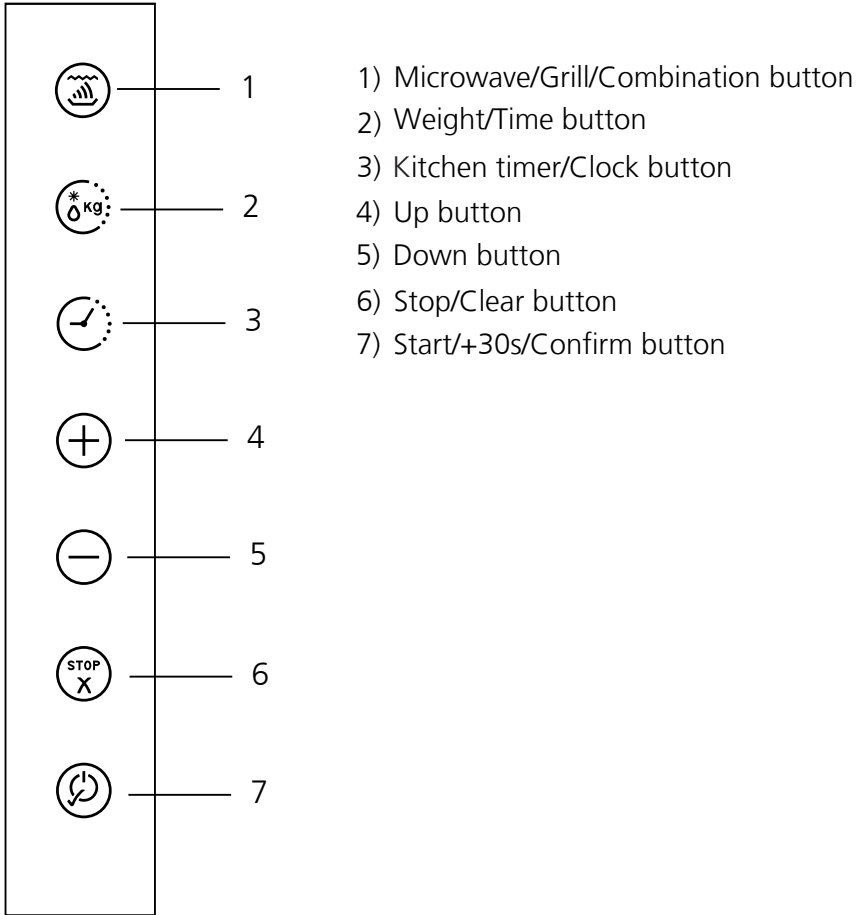







OPERATION INSTRUCTION

This microwave oven uses modern electronic control to adjust cooking parameters to meet your needs better for cooking.

1. Clock Setting

When the microwave oven is electrified, the oven will display "0:00", the buzzer will ring once.









- 1) Press " " twice, the hour figure flash;
- 2) Press " " or " " to adjust the hour figures, the input time should be within 0--23.
- 3) Press " ", the minute figures will flash.
- 4) Turn " " or " " to adjust the minute figures, the input time should be within 0--59.
- 5) Press " " to finish clock setting. ":" will flash.

The clock setting has now finished.

Note: 1) If the clock is not set, it will display 0:00 in waiting state.

- 2) During the process of clock setting, if you press " ", the oven will go back to the previous status automatically.

2. Microwave Cooking

- 1) Press the " " key once, and "P100" will display.
- 2) Press " " for times or press " " and " " to select the microwave power from 100% to 10%. "P100", "P80", "P50", "P30", "P10" will display in order.
- 3) Press " " to confirm.
- 4) Press " " or " " to adjust the cooking time.
(The time setting should be 0:05- 95:00.)
- 5) Press " " to start cooking.









NOTE: the step quantities for the adjustment time of the coding switch are as follow:

- 0---1 min : 5 seconds
- 1---5 min : 10 seconds
- 5---10 min : 30 seconds
- 10---30 min : 1 minute
- 30---95 min : 5 minutes

Microwave Power Chart

Microwave Power	100%	80%	50%	30%	10%
Display	P100	P80	P50	P30	P10

3. Grill or combination cooking



Press " " once the LED will display "P100", and press " " for times or press the " " or " " to choose the power you want, and "G", "C-1" or "C-2" will display. Then press " " to confirm, and press " " or " " to set cooking time from 0:05 to 95:00. Press " " again to start cooking.

Example: If you want to use 55% microwave power and 45% grill power(C-1) to cook for 10 minutes, you can operate the oven as the following steps.

- 1) Press " " once, the screen displays "P100".

- 2) Continue to press " " until the screen displays "C-1".

- 3) Press " " to confirm.

- 4) Press " " or " " to adjust the cooking time until the oven displays "10:00".





- 5) Press " " to start cooking .

Combination Power instructions:





Program	Display	Microwave Power	Grill Power
Grill	G	0%	100%
Combi.1	C-1	55%	45%
Combi.2	C-2	36%	64%

Note: If half the grill time passes, the oven sounds twice, this is normal. In order to have a better effect of grilling food, you should turn the food over, close the door, and then press " " to continue cooking. If no operation, the oven will continue working as previously set.

4. Defrost by weight

- 1) Press " " once, the screen will display "dEF1".
- 2) Press " " or " " to select the food weight. The range of weight is 100-2000g.
- 3) Press " " key to start defrosting.

5. Defrost By Time











- 1) Press " " twice, the screen will display "dEF2".
- 2) Press " " or " " to select the cooking time. The maximum time is 95 minutes.
- 3) Press " " key to start defrosting.

6. Multi-Stage Cooking





Two stages can be for cooking. If one stage is defrosting, it should be put in the first stage. The buzzer will ring once after each stage and the next stage will begin.

Note: Auto menu cannot be set as one of the multi-stage cooking options.

Example: if you want to defrost the food for 5 minutes, then to cook with 80% microwave power for 7 minutes. The steps are as following:





- 1) Press " " twice, the LED display "dEF2".
- 2) Press " " or " " to adjust the defrost time of 5 minutes;
- 3) Press " " once, LED will display "P100".
- 4) Press " " or " " to choose microwave power till "P80" display;
- 5) Press " " to confirm, LED will display "P80".
- 6) Press " " or " " to adjust the cooking time of 7 minutes;
- 7) Press " " to start cooking.

7. Kitchen Timer

- (1) Press " " once, LED will display 00:00.
- (2) Press " " or " " to enter the correct time.
(The maximum cooking time is 95 minutes)
- (3) Press " " to confirm setting, timer indicator will illuminate.
- (4) When the time is reached, the timer indicator will go out. The buzzer will ring 5 times.
If the clock is set (24-hour system), the LED will display the current time.

Note: The kitchen timer is differ from the 24-hour system, the Kitchen Timer is a timer only.





8. Auto Menu

- 1) Once switched on press "  " to choose the menu from "A-1" to "A-8".
- 2) Press "  " to confirm the menu you choose.
- 3) Press "  " or "  " to choose the food weight.
- 4) Press "  " to start cooking.
- 5) After cooking is finished, the buzzer sounds five times. The LED will display the current time or 0:00.

The menu chart:



Menu	Weight	Display
A-1 Pizza	200 g	200
	400 g	400
A-2 Meat	250 g	250
	350 g	350
	450 g	450
A-3 Vegetables	200 g	200
	300 g	300
	400 g	400
A-4 Pasta	50g(with 450 ml cold water)	50
	100g(with 800 ml cold water)	100
A-5 Potato	200 g	200
	400 g	400
	600 g	600
A-6 Fish	250 g	250
	350 g	350
	450 g	450
A-7 Beverage	1 cup(120 ml)	1
	2 cups(240 ml)	2
	3 cups(360 ml)	3
A-8 Popcorn	50 g	50
	100 g	100

9. Speedy cooking

- 1) In waiting state, press "  " key to cook with 100% power level for 30 seconds. Each press on the same key can increase 30 seconds. The maximum cooking time is 95 minutes.
- 2) During the microwave, grill, combination cooking and the defrost by time process, press "  " to increase the cooking time.
- 3) In waiting state, turn "  " to set cooking time with 100% microwave power, then press "  " to start cooking.



Note: Under the states of auto menu and defrost by weight, the cooking time cannot be increased by pressing "  " .

10. Lock function / Child lock



To Lock: In waiting state, press "  " for 3 seconds, there will be a long beep denoting entering the child-lock state and the current time will display if the time has been set, otherwise, the LED will display "  ". And the lock icon will illuminate.

To unlock: In locked state, press "  " for 3 seconds, there will be a long "beep" denoting that the lock is released.

11. Inquiring Function

- 1) In cooking states of microwave, grill and combination. Press "  " the current power will be displayed for 2-3 seconds.
- 2) During cooking state, press "  " to check the current time. It will be displayed for 2-3 seconds.

12. Specification

- (1) "  " must be pressed to continue cooking if the door is opened during cooking.
- (2) Once the cooking programme has been set , "  " is not pressed within 1 minute. The oven will turn back the waiting state, the setting will be cancelled.
- (3) Note the buzzer sounds once to confirm a selection or button press, there will be no response if the press did not register
- (4) After a cooking is finished, the buzzer sounds five times.

Trouble shooting

Normal	
Microwave oven interfering TV reception	Radio and TV reception may be interfered when microwave oven operating. It is similar to the interference of small electrical appliances, like mixer, vacuum cleaner, and electric fan. It is normal.
Dim oven light	In low power microwave cooking, oven light may become dim. It is normal.
Steam accumulating on door, hot air out of vents	In cooking, steam may come out of food. Most will get out from vents. But some may accumulate on cool place like oven door. It is normal.
Oven started accidentally with no food in.	It is forbidden to run the unit without any food inside. It is very dangerous, switch off Immediately.

Trouble	Possible Cause	Remedy
Oven can not be started.	(1) Power cord not plugged in tightly.	Unplug. Then plug again after 10 seconds.
	(2) Fuse blowing or circuit breaker works.	Replace fuse or reset circuit breaker (repaired by professional personnel of our company)
	(3) Trouble with outlet.	Test outlet with other electrical appliances.
Oven does not heat.	(4) Door not closed well.	Close door well.
Glass turntable makes noise when microwave oven operates	(5) Dirty roller rest and oven bottom.	Refer to "Maintenance of Microwave" to clean dirty parts.



According to Waste of Electrical and Electronic Equipment (WEEE) directive, WEEE should be separately collected and treated. If at any time in future you need to dispose of this product please do NOT dispose of this product with household waste. Please send this product to WEEE collecting points where available.

Caple
Fourth Way
Avonmouth
Bristol
BS11 8DW
www.caple.co.uk