

■ CAPLE ■

INSTALLATION AND OPERATING INSTRUCTION BOOKLET

C770G/W & C780G/W Gas on Glass Hobs



IMPORTANT: You must read this instruction Book before installing or using this appliance and retain it for future use.

Caple Products

Telephone 0870 2411142

Facsimile 0117 982 6878

Thank you for buying your new CAPLE Gas on Glass Hob. To ensure that you get the best results from your Gas on Glass Hob, we strongly suggest that you read this instruction manual thoroughly before use. This manual contains installation advice, usage instructions and a cleaning guide, as well as other important facts about your CAPLE Gas on Glass Hob. If treated with care, your CAPLE Gas on Glass Hob should give you years of trouble-free use.

IMPORTANT WARNINGS AND ADVICE

After unpacking, make sure that the appliance is in perfect order. If you have any doubt, do not use it and contact the retailer or call a qualified engineer.

Pieces of packing (plastic bags, polystyrene, nails, metal, etc.) must not be left within the reach of children because they are potential sources of danger.

- Do not try to modify the appliance's technical characteristics because this could be dangerous
- Do not clean or maintain the appliance without previously disconnecting it
- Do not let children or people who are not capable use the appliance without supervision.

The manufacturer declines any responsibility for damage caused by incorrect, mistaken or irrational use.

THIS APPLIANCE COMPLIES WITH THE FOLLOWING DIRECTIVES:

EEC 73/23 and 93/88

(Low Voltage)

EEC 89/336

(Electromagnetic Compatibility)

EEC 89/109

(Contact with foods)

**For Spare Parts, Technical Advice
or Product Service call the
CAPLE HELPLINE on 0870 2411142
(Answer phone outside office hours)**



GENERAL NOTICE

We invite you to read this instruction booklet carefully, before installing and using the equipment. It is very important that you keep this booklet together with the equipment for any future consultation.

If this equipment should be sold or transferred to another person, make sure that the new user receives the booklet, so that he can learn how to operate the appliance and read the corresponding notice.

- The installation must be carried out by experienced and qualified personnel, in conformity with the regulations in force.
- This equipment has been designed to be used by adults.
- Therefore, make sure that children do not go near the equipment to play with it.
- While the appliance is running, watch the children and make sure they neither stay near the equipment, nor touch the surfaces that have not cooled down completely.
- Before powering the equipment, check that it is properly adjusted for the type of gas at disposal (see the "installation" paragraph).
- Before carrying out any maintenance or cleaning the equipment, cut power supply off and make sure appliance is cool.
- Make sure that air circulates around the gas equipment. Insufficient ventilation produces a lack of oxygen.
- In case of an intense or prolonged use of the equipment, it may be necessary to improve aeration, for example by opening a window or increasing the mechanical suction power, if it exists.
- The products of combustion must be discharged outside through a suction hood or an electric fan (see the "installation" paragraph).
- For any possible operation or modification, apply to an authorised Technical Assistance Centre and demand original spare parts.

DESCRIPTION

1 Rapid burner 3000 W

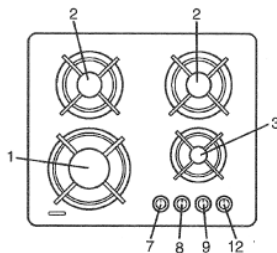

2 Semi-rapid burner 1650 W

3 Auxiliary burner 1000 W

6 Control Knob for burner 4

7 Control Knob for burner 1

8 Control Knob for burner 2 (left rear)

9 Control Knob for burner 2 (right rear)

10 Control Knob for burner 2 (right front)

11 Control Knob for burner 2 (central)

12 Control Knob for burner 3 (right front)

13 Control Knob for burner 3 (left front)

A

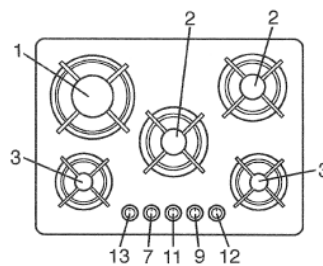

INSTRUCTIONS

C

FOR THE USER

IT IS NECESSARY THAT ALL THE OPERATIONS REGARDING THE INSTALLATION, ADJUSTMENT AND ADAPTATION TO THE TYPE OF GAS AVAILABLE ARE CARRIED OUT BY QUALIFIED PERSONNEL, IN CONFORMITY WITH THE REGULATIONS IN FORCE.

THE SPECIFIC INSTRUCTIONS ARE DESCRIBED IN THE BOOKLET SECTION INTENDED FOR THE INSTALLER

USING THE BURNERS

The symbols silk-screen printed on the side of the knob indicate the correspondence between the knob and the burner.

Automatic start-up without valves

Turn the corresponding knob anticlockwise up to the maximum position (large flame, fig. 1) and press the knob.

Automatic start-up with valves

Turn the corresponding knob anticlockwise up to the maximum position (large flame, fig.1) and press the knob. Once the burner has been started up, keep the knob pressed for about 10 seconds.

Using the burners

In order to obtain the maximum yield without waste of gas, it is important that the diameter of the pot is suitable for the burner potential (see the following table), so as to avoid that the flame goes out of the pot bottom (fig.2).

Use the maximum capacity to quickly make the liquids reach the boiling temperature, and the reduced capacity to heat food or maintain boiling. All of the operating positions must be chosen between the maximum and the minimum ones, never between the minimum position and the closing point.

The gas supply can be interrupted by turning the knob clockwise up to the closing position. If there is no power supply, it is possible to light the burners with matches, setting the knob to the startup point (large flame).

Burners	Power W	Dia. Of Pans
Auxiliary	1000	10-14 cm
Semi-rapid	1650	16-18 cm
Rapid	3000	20-22 cm
Ultra-rapid	3300	24-26 cm

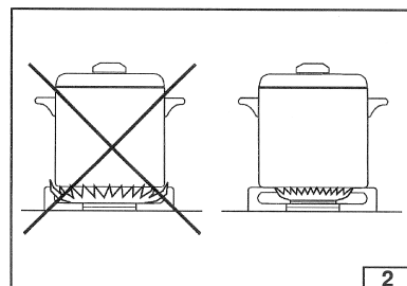
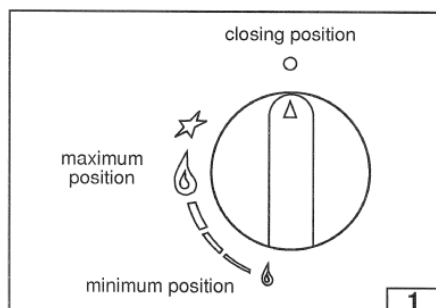

INSTRUCTIONS FOR THE USER

USING THE BURNERS

- When the equipment is not working, always check that the knobs are in the closing position (see fig. 1).
- If the flame should blow out accidentally, the safety valve will automatically stop the gas supply after a few seconds. To restore operation, set the knob to the lighting point (large flame, fig.1).
- While cooking with fat or oil, pay the utmost attention as these substances can catch fire when overheated.
- Do not use sprays near the appliance in operation.
- Do not place unstable or deformed pots on the burner, so as to prevent them from overturning or overflowing.
- Make sure that pot handles are placed properly.
- When the burner is started up, check that the flame is regular and, before taking pots away, always lower the flame or put it out.

KNOB SETTING	HEAT	TYPE OF COOKING
0	Off	
1	Very low	To heat small quantities of liquids.
2	Low	Heating medium quantities of liquid, to prepare sauces and creams requiring long cooking.
3	Mild	To defrost frozen foods, cook stews, at to below boiling point.
4	Medium	For foods which require boiling point, delicate meat and fish.
5	Strong	For roasting, grilling , stews.
6	Very strong	To boil large quantities of liquid , to fry.

CLEANING INSTRUCTIONS FOR THE USER

- Before any operation, disconnect the appliance from the electricity supply. It is also advisable to clean the appliance when it is cold.
- The glass platform and all of the enameled parts must be washed with a sponge and soapy water or with a light detergent.
- Do not use abrasive or corrosive products.
- Do not leave substances, such as lemon or tomato juice, salt water, vinegar, coffee and milk on the enameled surfaces for a long time.
- Burners & Pan Supports can be removed to make cleaning easier.
- The burners must be washed with a sponge and soapy water or with a light detergent, wiped well and placed in their housing perfectly. Make sure that the flame-dividing ducts are not clogged.
- Check that the feeler of the safety valve and the start-up electrode are always perfectly cleaned, so as to ensure an optimum operation. The racks can be washed in the dishwasher.
- The possible lubrication of the Gas Taps must be carried out by specialised personnel, exclusively. In case of hardening or malfunctions in the gas taps, apply to the Customer Service.

INSTRUCTIONS FOR THE INSTALLER



IMPORTANT NOTICE

THE OPERATIONS INDICATED BELOW MUST BE FOLLOWED BY QUALIFIED PERSONNEL EXCLUSIVELY, IN CONFORMITY WITH THE REGULATIONS IN FORCE.

THE MANUFACTURING FIRM REFUSES ALL RESPONSIBILITY FOR DAMAGES TO PEOPLE, ANIMALS OR THINGS, RESULTING FROM THE FAILURE TO COMPLY WITH SUCH PROVISIONS.

Installing the top

The appliance is designed to be embedded into heat-resistant pieces of furniture.

The walls of the pieces of furniture must resist a temperature of 65°C besides the room one.

The equipment must not be installed near inflammable materials, such as curtains, cloths, etc.

Make a hole in the top of the piece of furniture, with the dimensions indicated in fig.3, at a distance of at least 50 mm from the appliance border to the adjacent walls.

Any possible wall unit over the cook-top must be placed at a distance of at least 760 mm from the top. It is advisable to isolate the appliance from the piece of furniture below with a separator, leaving a depression space of at least 10 mm (fig.4).

APPLIANCE DIMENSIONS	L	P
700 x 510	550	470
600 x 510	550	470
290 x 510	268	490

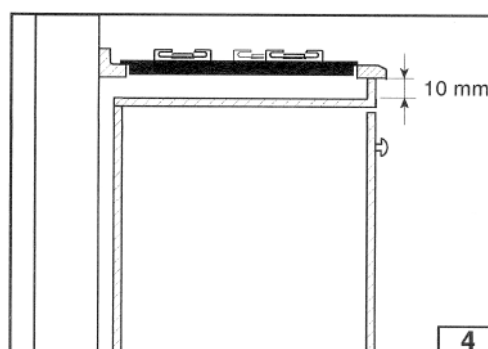
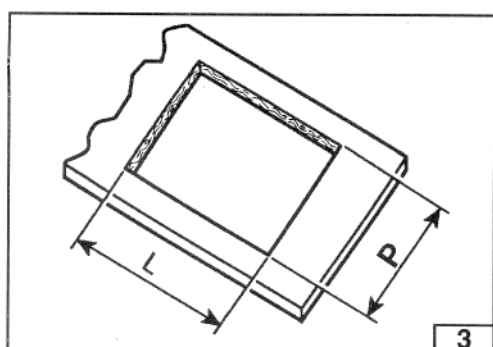

Fastening the top

Every cook-top is equipped with a special gasket having an adhesive side.

- Remove the racks and burners from the top.
- Turn the appliance upside down and lay the adhesive washer S along the external border of the glass (fig.5).
- Introduce and place the cook-top in the hole made in the piece of furniture, then block it with the V screws of the fastening hooks G (fig.6).

Installation room

This appliance is not provided with a device for exhausting the products of combustion, therefore, it is necessary to discharge the fumes outside. The room where this appliance is installed must have a natural air inflow, so as to ensure a regular gas combustion and room ventilation: the necessary air volume must not be lower than 20 m³.

Air must come from permanent openings made on the room walls that communicate with the outside.

The section of these openings shall correspond to at least 200 cm².

Gas connection

Make sure that the appliance is adjusted for the gas type available (see the label under the appliance). Follow the instructions indicated in the chapter "gas transformations and adjustments" for the possible adaptation to different gases. The appliance must be connected to the gas system by means of stiff metal pipes or flexible steel pipes having continuous walls, in compliance with the regulations in force.

Gas enters the appliance through a cylindrical threaded male gas union (1/2").

The connection must not stress the gas ramp.

Once the installation is over, check the connection seal with a soapy solution.

Electric connection

The connection to the electric grid must be carried out by qualified personnel and in conformity with the regulations in force.

The voltage of the electric system must correspond to the value indicated in the label under the appliance. Make sure that the electric system is provided with an effective ground connection in compliance with the regulations and provisions of the law. Grounding is compulsory. If the appliance is not equipped with a plug, apply a standardised plug to the power supply cable.

It is possible to effect the connection to the electric grid directly, by interposing an omni polar switch having a contact opening distance of at least 3 mm.

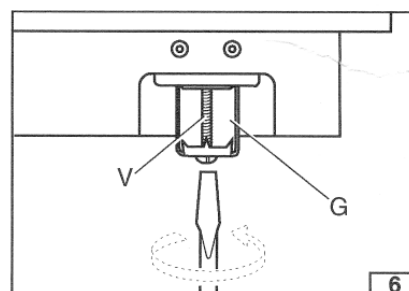
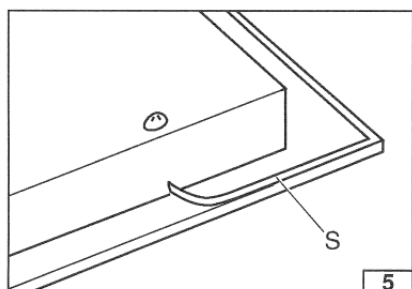

GAS ADJUSTMENTS

Replacing the nozzles

If the equipment is adjusted for a type of gas that is different from the one available, it is necessary to replace the burner nozzles. The choice of the nozzles to replace must be made according to the table of the "technical characteristics". Act as follows: -

- Remove the racks and burners.
- By means of a straight spanner L, unscrew the nozzle U (fig.7) and substitute it with the corresponding one.
- Tighten the nozzle strongly.

Adjusting the burners

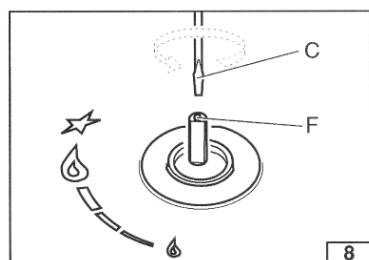
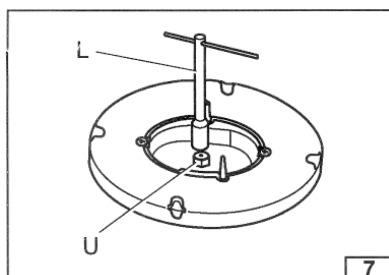

- The lowest flame point must always be properly adjusted and the flame must remain on even if there is an abrupt shift from the maximum to the minimum position. If this is not so, it is necessary to adjust the lowest flame point as follows: -
- Start the burner up.
- Turn the tap up to the minimum position (small flame)
- Remove the knob from the tap rod.
- Introduce a flat-tip screwdriver C in the hole F of the tap (fig.8) and turn the by-pass screw up to a proper adjustment of the lowest flame point.

As regards G 30 gas burners, the by-pass screw must be tightened completely.

MAINTENANCE

Lubricating the taps

In case of tap becoming stiff, it is necessary to disassemble and grease it.

These are the operations to carry out:

- Unscrew the two screws that lock the head flange of the tap.
- Lift the gas adjusting cone and carefully clean it with gasoline or diluent.
- Spread a little high-temperature grease on it, making sure that the gas holes are not obstructed.
- Reassemble all of the parts with care.

Replacing the power supply cable

If the power supply cable should be replaced, it is necessary to use a cable with a section of 3 x 0.75 mm², type H05VV-F or H05RR-F, complying with the regulations in force. The connection to the terminal board must be effected as shown in fig. 9:

Brown cable	L	(live)
Blue cable	N	(neutral)
Green-yellow cable	E	(earth)

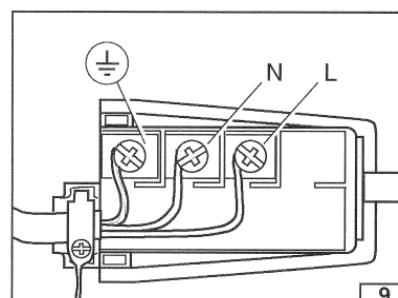

TECHNICAL CHARACTERISTIC TABLES

BURNERS		GAS	NORMAL PRESSURE	NOMINAL RATE		INJECTOR DIAMETER	TAP BY PASS DIAMETER	NOMINAL HEAT INPUT (WATT)	
				g/h	L/h			1/100 mm	1/100 mm
1	RAPID	G30	30	218	-	85	40	3000	900
		G31	37	214	-	85	40	3000	900
		G20	20	-	274	128	Reg.	3000	900
2	SEMI-RAPID	G30	30	120	-	65	29	1650	600
		G31	37	118	-	65	29	1650	600
		G20	20	-	154	94	Reg.	1650	600
3	AUXILIARY	G30	30	73	-	50	27	1000	450
		G31	37	72	-	50	27	1000	450
		G20	20	-	95	76	Reg.	1000	450
4	ULTRA-RAPID	G30	30	240	-	92	60	3300	1850
		G31	37	236	-	92	60	3300	1850
		G20	20	-	312	139	Reg.	3300	1850

DESCRIPTION (page 4)	A – B	D	C	E	F	G
GAS RATES	531 g/h 7,3 kW	553 g/h 7,6 kW	604 g/h 8,3 kW	240 g/h 3,3 kW	291 g/h 4 kW	411 g/h 5,65 kW
VOLTAGE	230 V 50 Hz	230 V 50 Hz	230 V 50 Hz	230 V 50 Hz	230 V 50 Hz	230 V 50 Hz
POWER RATING	–	–	–	–	–	1500 W

CAPLE "Built-in" Service

Should you require service at any time, please contact the **Caple Help line on 0870 2411142**.

Caple have a nationwide service network of engineers who will respond quickly to your call.

Always replace spare parts with genuine Caple spares. These are available from authorised **Caple Service Centres** or by mail order from our **National Service Stores, simply telephone 0870 2411142**. When ordering parts always quote the model number and serial number of your appliance.

YOUR GUARANTEE

CAPLE guarantees all parts of this product for one year from the date of purchase. During that time, should it become necessary CAPLE engineers will replace or repair all defective parts free of charge, except for parts subject to fair wear and tear, such as light bulbs.

Parts and the engineers labour costs are chargeable after the first 12 months.

To qualify for benefits under the guarantee, you must be able to provide proof of date of purchase and the appliance must have been supplied, installed and used for domestic purposes only in accordance with CAPLE instructions.

Consequential losses and accidental damage to the product are not covered by the guarantee.

This guarantee does not affect your statutory or common law rights.

CAPLE cannot be responsible for the results of using this appliance for any other purposes other than those described in these instructions.